

Service Manual

AV Control Stereo Receiver

SA-EX140

Color

(K) ... Black Type

E ... Europe

EB ... Great Britain

EG ... Germany and Italy

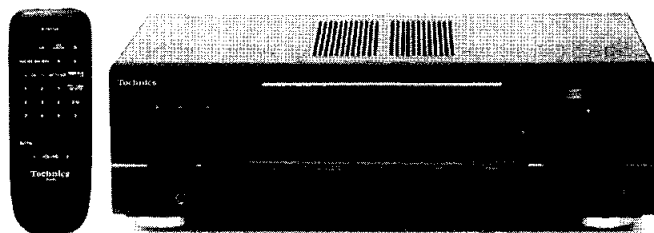

■ FM Tuner Section

Frequency Range	87.50-108.00 MHz
Sensitivity	
S/N 30 dB	1.5 μ V/75 Ω
S/N 26 dB	1.3 μ V/75 Ω
S/N 20 dB	1.2 μ V/75 Ω
IHF usable sensitivity	1.5 μ V/75 Ω (IHF '58)
IHF 46 dB stereo quieting sensitivity	22 μ V/75 Ω
Total harmonic distortion	
MONO	0.2%
STEREO	0.3%
S/N	
MONO	60 dB (73 dB, IHF)
STEREO	58 dB (67 dB, IHF)
Frequency response 20 Hz-15 kHz	+1 dB, -2 dB
Alternate channel selectivity \pm 400 kHz	65 dB
Capture ratio	1.5 dB
Image rejection at 98 MHz	40 dB
IF rejection at 98 MHz	70 dB
Spurious response rejection at 98 MHz	70 dB
AM suppression	50 dB
Stereo separation	
1 kHz	40 dB
Carrier leak	
19 kHz	-30 dB (-35 dB, IHF)
38 kHz	-50 dB (-55 dB, IHF)
Channel balance (250 Hz-6.3 kHz)	\pm 1.5 dB
Limiting point	1.2 μ V

Bandwidth

IF amplifier	180 kHz
FM demodulator	1000 kHz
Antenna terminal	75 Ω (unbalanced)

■ AM Tuner Section

Frequency Range	522-1611 kHz
Sensitivity	20 μ V, 330 μ V/m
Selectivity (at 999 kHz)	55 dB
IF rejection (at 999 kHz)	50 dB

■ Amplifier Section

Power output	
DIN 1 kHz (T.H.D. 1%)	2 x 100 W (4 Ω)
40 Hz-20 kHz continuous power output both channels driven	2 x 80 W (8 Ω)
Total harmonic distortion	
rated power at 40 Hz-20 kHz	0.5% (8 Ω)
half power at 1 kHz	0.07% (8 Ω)
Power bandwidth	
both channels driven. -3 dB	10 Hz-40 kHz (8 Ω)
Damping factor	30 (8 Ω)
Load impedance	
Front	4-16 Ω
Frequency response	
PHONO	RIAA standard curve (30 Hz-15 kHz) \pm 0.8 dB
CD, TAPE, VCR	10 Hz-40 kHz, \pm 3 dB
Input sensitivity and impedance	
PHONO	3 mV/47 k Ω

Technics[®]

© 2000 Matsushita Electronics (S) Pte. Ltd. All rights reserved. Unauthorized copying and distribution is a violation of law.

CD, TAPE, VCR	200 mV/22 k Ω	■ General	
S/N at rated power (8 Ω)		Power supply	AC 230-240 V, 50 Hz (For EB only)
PHONO	70 dB (IHF, A: 80 dB)		
CD, TAPE, VCR	75 dB (IHF, A: 85 dB)		AC 230 V, 50 Hz (For E/EG only)
Tone controls		Power consumption	190 W
BASS	50 Hz, +10 to -10 dB		(in standby condition: 3 W)
TREBLE	20 kHz, +10 to -10 dB	Dimensions (W x H x D)	430 x 136 x 312 mm
Output voltage		Weight	7.0 kg
TAPE REC (OUT), VCR OUT	200 mV		
Channel balance (250 Hz-6.3 kHz)	± 1 dB	Notes:	
Channel separation	55 dB	1. Specifications are subject to change without notice.	
Headphones output level and impedance	430 mV/330 Ω	Weight and dimensions are approximate.	
		2. Total harmonic distortion is measured by the digital spectrum analyzer.	

WARNING

This service information is designed for experienced repair technicians only and is not designed for use by the general public. It does not contain warnings or cautions to advise non-technical individuals of potential dangers in attempting to service a product. Products powered by electricity should be serviced or repaired only by experienced professional technicians. Any attempt to service or repair the product or products dealt with in this service information by anyone else could result in serious injury or death.

CONTENTS

	Page		Page
1 Before Repair and Adjustment	3	8 Type Illustrations of ICs, Transistors & Diodes	14
2 Protection Circuitry	3	9 Terminal Functions of ICs	15
3 Accessories	3	10 Block Diagram	16
4 Caution for AC Mains Lead	4	11 Schematic Diagram	19
5 Front Panel Controls	5	12 Printed Circuit Board	27
6 Operation Checks and Main Component Replacement Procedures	6	13 Wiring Connection Diagram	34
7 Troubleshooting	11	14 Parts Location and Replacement Parts List	35

1 Before Repair and Adjustment

Disconnect AC power, discharge Power Supply Capacitors C753 through a 10 Ω , 5 W resistor to ground. DO NOT SHORT-CIRCUIT DIRECTLY (with a screw driver blade, for instance), as this may destroy solid state devices.

After repairs are completed, restore power gradually using a variac, to avoid over current.

Current consumption at AC 230 V, 50 Hz in NO SIGNAL mode should be 130~190 mA. (E/EG)

Current consumption at AC 230 - 240 V, 50 Hz in NO SIGNAL mode should be 130~190 mA. (EB)

2 Protection Circuitry

The protection circuitry may have operated if either of the following conditions are noticed:

- No sound is heard when the power is turned on.
- Stops during a performance.

The function of this circuitry is to prevent circuitry damage if, for example, the positive and negative speaker connection wires are "shorted", or if speaker systems with an impedance less than the indicated rated impedance of the amplifier are used.

If this occurs, follow the procedure outlines below:

1. Turn off the power.
2. Determine the cause of the problem and correct it.
3. Turn on the power once again after one minute.

Note:

When the protection circuitry functions, the unit will not operate unless the power is first turned off and then on again.

3 Accessories

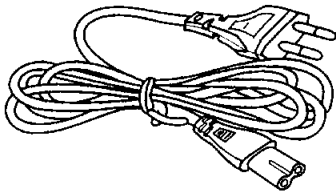

AC power supply cord (E/EG)... 1 pc.

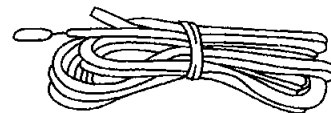

FM Indoor Antenna... 1 pc.

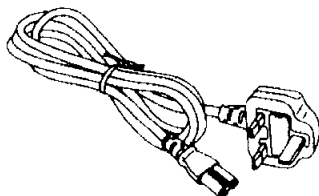

AC power supply cord (EB)... 1 pc.

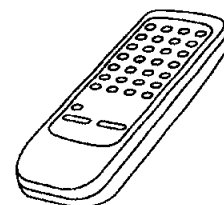

Remote Control Transmitter... 1 pc.

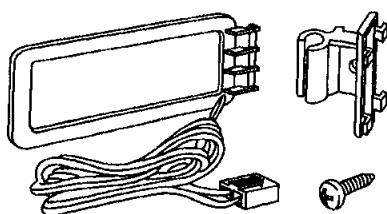

AM Loop Antenna Set
... 1 set.

4 Caution for AC Mains Lead



(For "EB" area code model only.)

For your safety, please read the following text carefully.

This appliance is supplied with a moulded three pin mains plug for your safety and convenience.

A 5-ampere fuse is fitted in this plug.

Should the fuse need to be replaced please ensure that the replacement fuse has a rating of 5-ampere and that it is approved by ASTA or BSI to BS1362.

Check for the ASTA mark  or the BSI mark  on the body of the fuse.

If the plug contains a removable fuse cover you must ensure that it is refitted when the fuse is replaced.

If you lose the fuse cover, the plug must not be used until a replacement cover is obtained.

A replacement fuse cover can be purchased from your local dealer.

CAUTION!

IF THE FITTED MOULDED PLUG IS UNSUITABLE FOR THE SOCKET OUTLET IN YOUR HOME THEN THE FUSE SHOULD BE REMOVED AND THE PLUG CUT OFF AND DISPOSED OFF SAFELY.

THERE IS A DANGER OF SEVERE ELECTRICAL SHOCK IF THE CUT OFF PLUG IS INSERTED INTO ANY 13-AMPERE SOCKET.

If a new plug is to be fitted, please observe the wiring code as shown below.

If in any doubt please consult a qualified electrician.

IMPORTANT

The wires in this mains lead are coloured in accordance with the following code:

Blue: Neutral
Brown: Live

As these colours may not correspond with the coloured markings identifying the terminals in your plug, proceed as follows:

The wire which is coloured Blue must be connected to the terminal which is marked with the letter N or coloured Black or Blue.

The wire which is coloured Brown must be connected to the terminal which is marked with the letter L or coloured Brown or Red.

WARNING: DO NOT CONNECT EITHER WIRE TO THE EARTH TERMINAL WHICH IS MARKED WITH THE LETTER E, BY THE EARTH SYMBOL  OR COLOURED GREEN OR GREEN/YELLOW.

THIS PLUG IS NOT WATERPROOF—KEEP DRY.

Before use

Remove the connector cover.

How to replace the fuse

The location of the fuse differ according to the type of AC mains plug (figures A and B). Confirm the AC mains plug fitted and follow the instructions below.

Illustrations may differ from actual AC mains plug.

1. Open the fuse cover with a screwdriver.

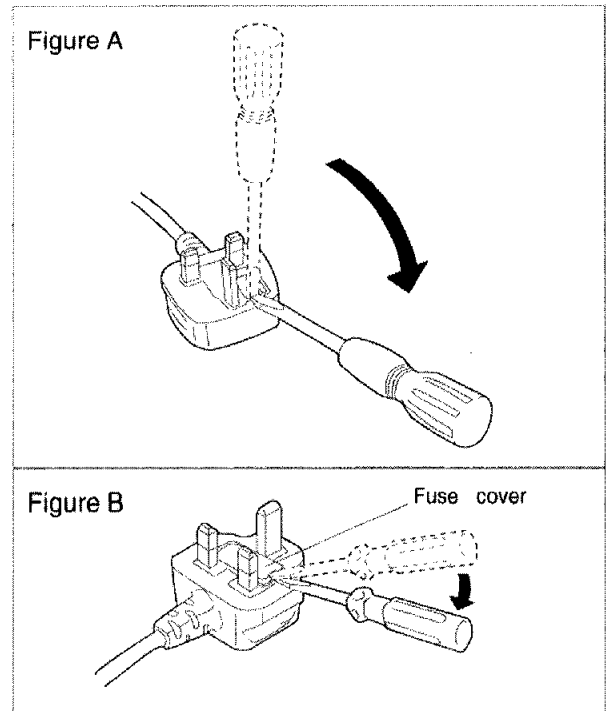

2. Replace the fuse and close or attach the fuse cover.

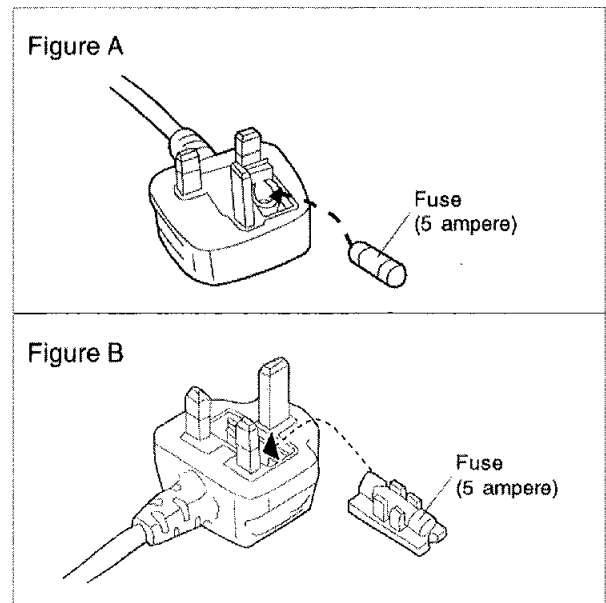

5 Front Panel Controls

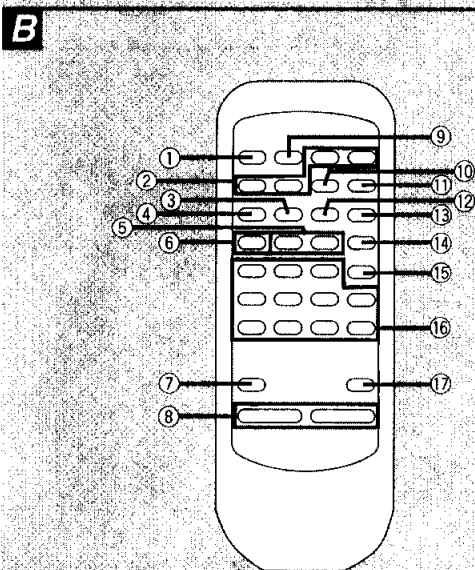
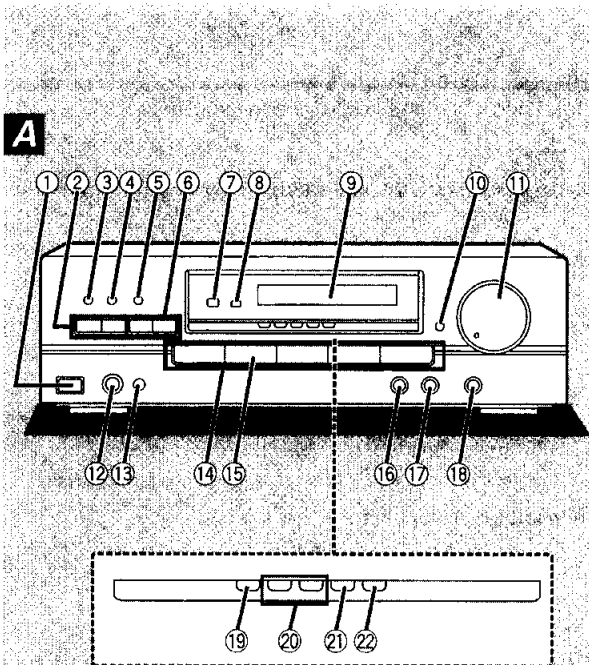

Front panel controls

Main unit

- ① **Standby/on switch (⏻/⏻)**
Press to switch the unit from on to standby mode or vice versa. In standby mode, the unit is still consuming a small amount of power.
- ② **Tuning buttons (∨ TUNING ∧)**
- ③ **Band select button (BAND)**
- ④ **FM mode select button (FM MODE)**
- ⑤ **Memory button (MEMORY)**
- ⑥ **Preset channel buttons (∨ PRESET ∧)**
- ⑦ **Remote control signal sensor (SENSOR)**
- ⑧ **“STANDBY” indicator (⏻)**
When the unit is connected to the AC mains supply, this indicator lights up in standby mode and goes out when the unit is turned on.
- ⑨ **Display**
- ⑩ **Muting button (MUTING)**
- ⑪ **Volume control (VOLUME)**
- ⑫ **Headphone jack (PHONES)**
- ⑬ **Speaker ON/OFF button (SPEAKERS)**
- ⑭ **Input select buttons**
- ⑮ **Tape monitor button (TAPE MONITOR)**
- ⑯ **Bass control (BASS)**
- ⑰ **Treble control (TREBLE)**
- ⑱ **Balance control (BALANCE)**
- ⑲ **RDS display mode select button (DISPLAY MODE)**
- ⑳ **PTY select buttons (PTY SELECT)**
- ㉑ **EON ON/OFF button (EON)**
- ㉒ **PTY search button (SEARCH)**

Remote control

- ① **Standby/on button (⏻)**
- ② **Input and mode select buttons (TV, VCR, TUNER, CD)**
- ③ **▶▶ / ▶▶▶ button (▶▶ / ▶▶▶)**
- ④ **◀◀ / ◀◀ button (◀◀ / ◀◀)**
- ⑤ **TV Volume buttons (- TV VOL +)**
- ⑥ **TV/AV button (TV/AV)**
- ⑦ **Muting button (MUTING)**
- ⑧ **Volume buttons (- VOLUME +)**
- ⑨ **Audio standby button (AUDIO ⏻)**
- ⑩ **Tape monitor button (TAPE MONITOR)**
- ⑪ **■ button (■)**
- ⑫ **◀ button (◀)**
- ⑬ **▶ button (▶)**
- ⑭ **Disc/Deck 1/2 button (DISC/DECK 1/2)**
- ⑮ **Direct tuning/disc enter button (DIRECT TUNING/DISC ENTER)**
- ⑯ **Numbered buttons**
- ⑰ **Sleep button (SLEEP)**

6 Operation Checks and Main Component Replacement Procedures

“ATTENTION SERVICER”

Some chassis components maybe have sharp edges. Be careful when diassembling and servicing.

1. This section describes procedures for checking the operation of the major printed circuit boards and replacing the main components.
2. For reassembly after operation checks or replacement, reverse the respective procedures.
Special reassembly procedures are described only when required.
3. Select items from the following index when checks or replacement are required.

Content

- **Checking Procedure for each major P.C.B.**..... P.g. 6~8
- **Main Component Replacement Procedures**
 1. Replacement of Power IC and Regulator Transistor..... P.g. 8~9
 2. Replacement of Fan Motor..... P.g. 9~10

6.1. Checking Procedure for each major P.C.B.

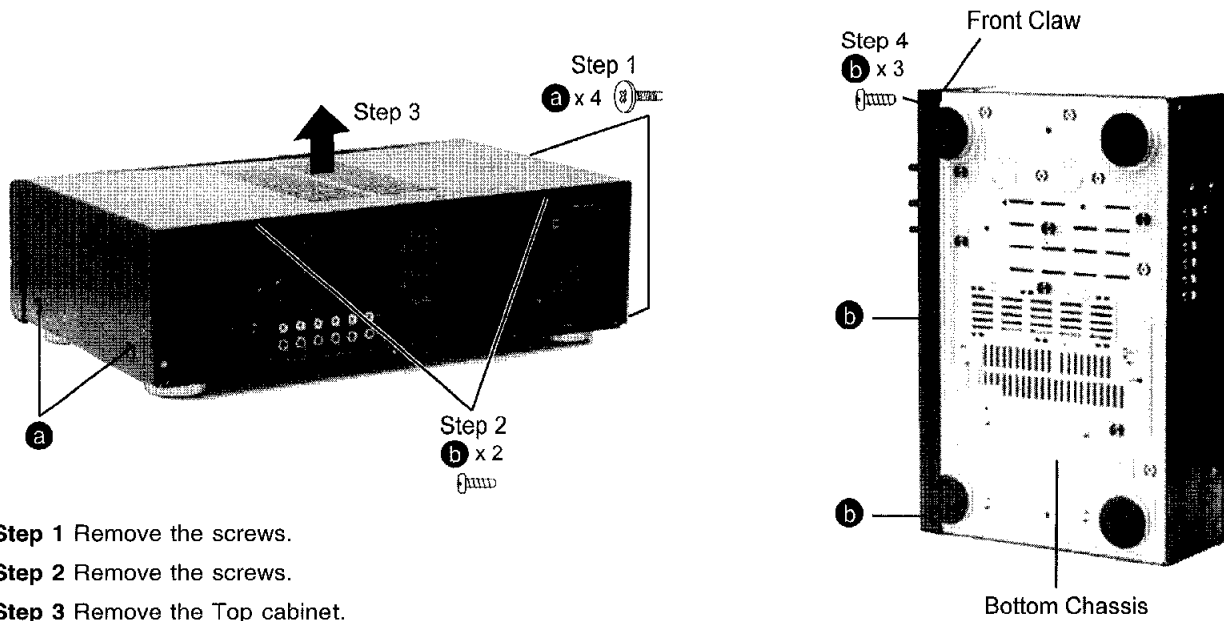

Step 1 Remove the screws.

Step 2 Remove the screws.

Step 3 Remove the Top cabinet.

Step 4 Remove the screws.

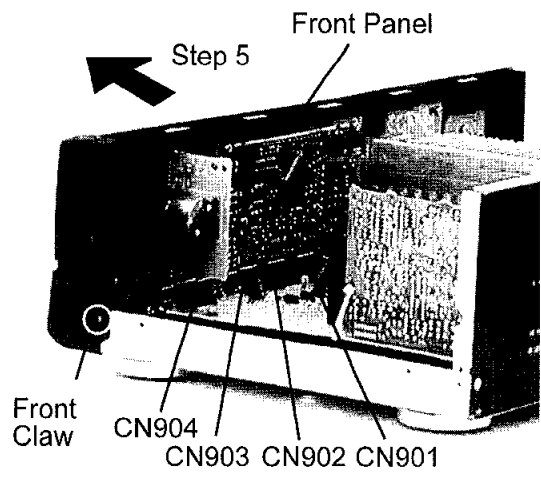

Step 5 Release the two front claws and pull out the front panel as shown above. Take note of the connectors as you remove the front panel. (CN901 to CN904)

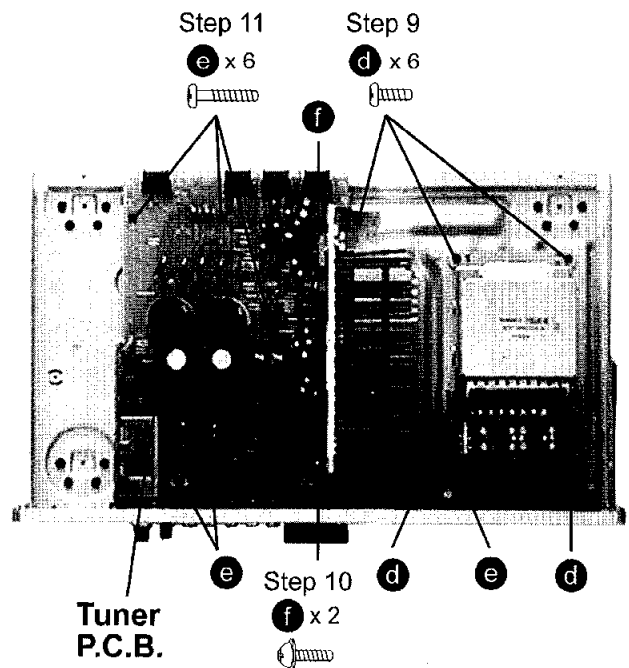

Step 9 Remove the screws.
Step 10 Remove the screws.
Step 11 Remove the screws.

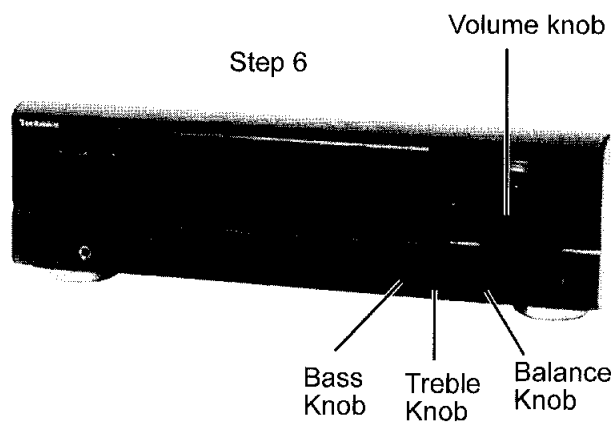

Step 6 Remove Balance, Treble, Bass and Volume knob.

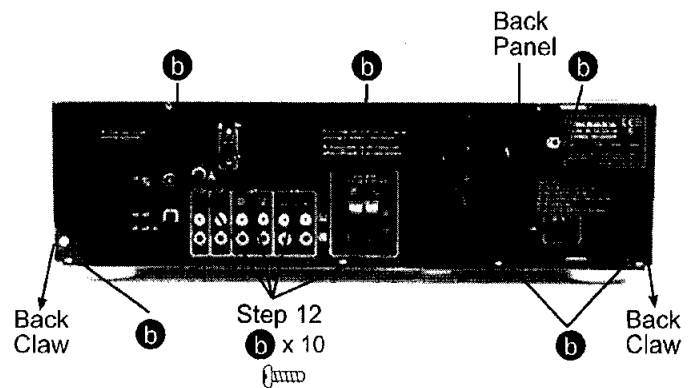

Step 12 Remove the screws from back panel.

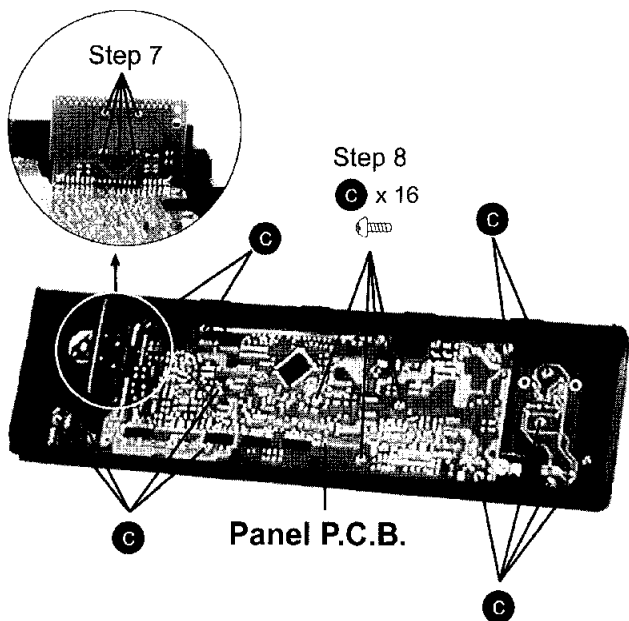

Step 7 Desolder the area shown.
Step 8 Remove the screws.

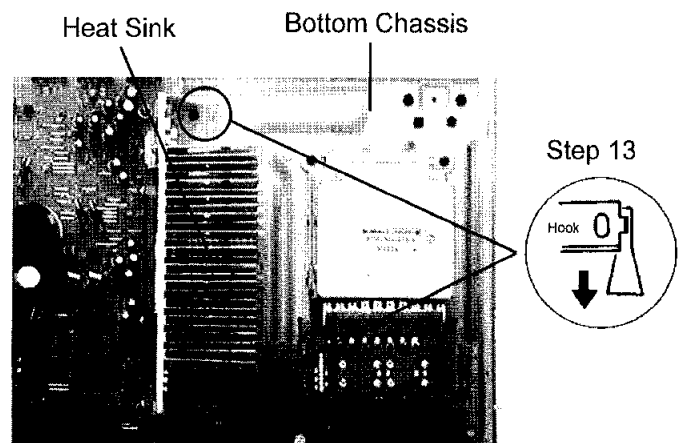

Step 13 Release the two back claws and the hooks of the heat sink. Slide out the bottom chassis from the main P.C.B. and the back panel.

Step 14
Main P.C.B.

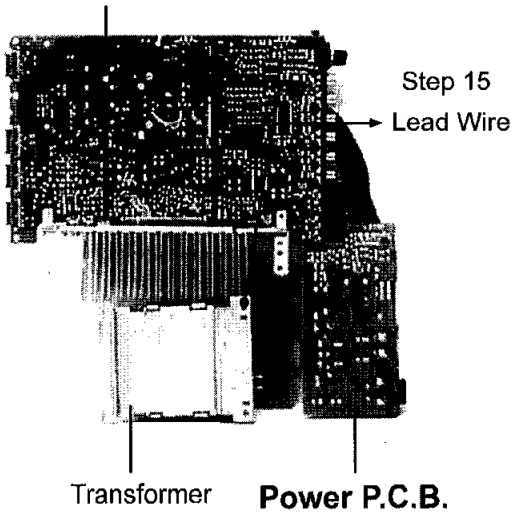

Step 14 Check the Main P.C.B., Tuning P.C.B. and Power P.C.B. as shown as above.

Step 15 Connect back the transformer to the Power P.C.B. and connect a lead wire from the Main P.C.B. ground to the transformer ground plate.

6.2. Main Component Replacement Procedures

6.2.1. Replacement of Power IC and Regulator Transistor

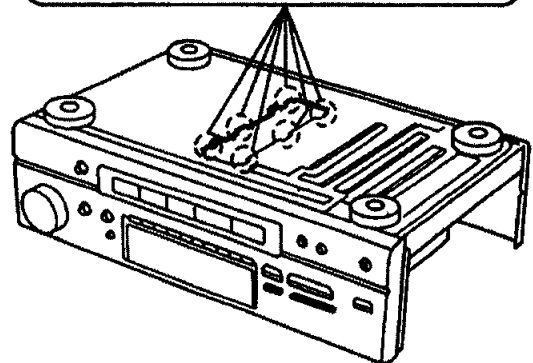
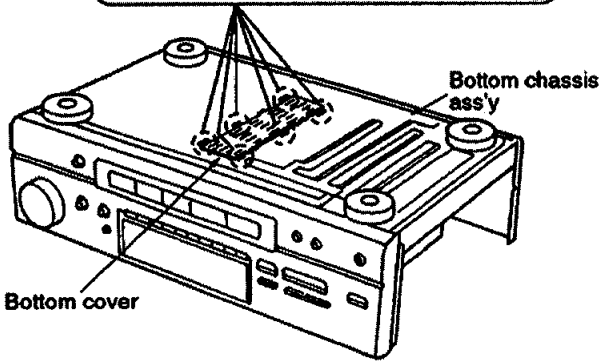
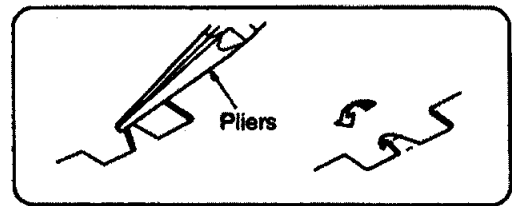
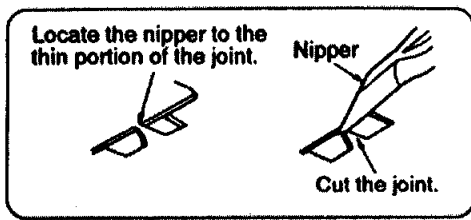

1. Cut the joints (6 portions) between bottom cover and bottom chassis ass'y with nipper.

2. After cutting the joints (6 portions), bend the portions of the bottom chassis ass'y in the direction of arrow with pliers.

Unsolder the terminals of power IC or regulator transistor

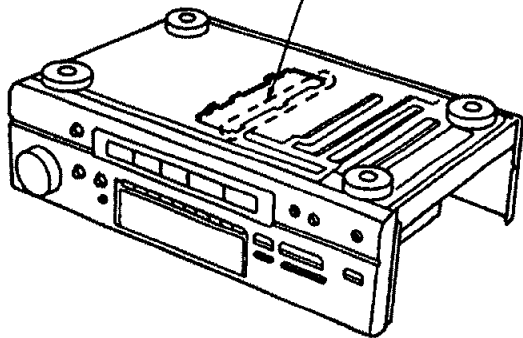

3. When replacing the power IC or regulator transistor, unsolder the terminals of power IC or regulator transistor on the soldered surface.

CAUTION

- After replacing the power IC or regulator transistor, apply a sufficient quantity of compound grease between the heat sink and the power IC or regulator transistor (Radiation of power IC & transistor)
- Tighten enough the screws (① ~ ③) after replacing the power IC or regulator transistor. Otherwise, the heat radiation works little.

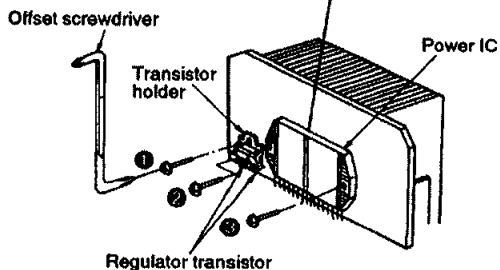

4. Then remove the 3 screws (1~3) fixed to the power IC or transistor holder.
 5. When installing or removing the power IC or transistor holder, be sure to use an offset screwdriver.

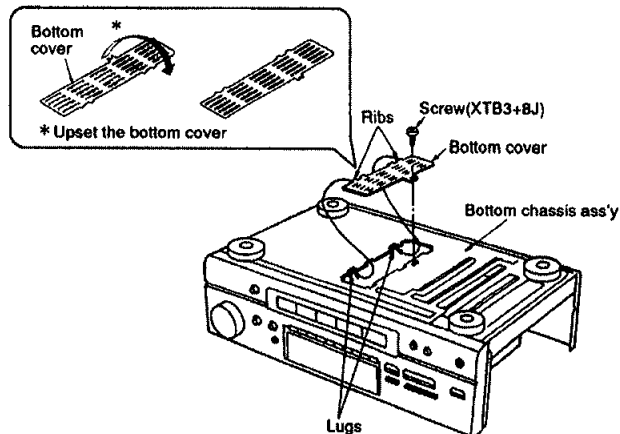

6. After replacing the power IC or regulator transistor, upset the bottom cover and align the ribs of the bottom cover to the lugs on the bottom chassis ass'y.

7. After mounting the bottom cover on the bottom chassis ass'y, fix it with a screw(XTB3+8J).

6.2.2. Replacement of Fan Motor

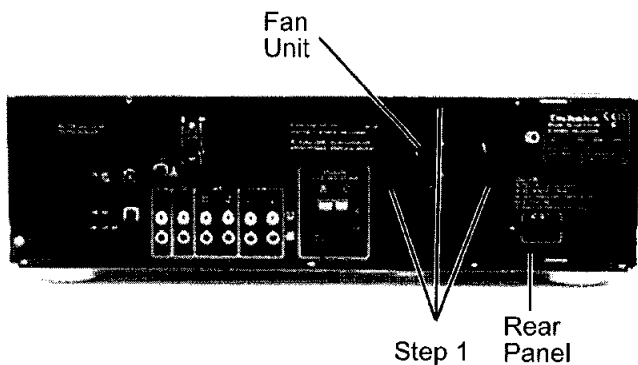

Step 1 Release the 3 claws.

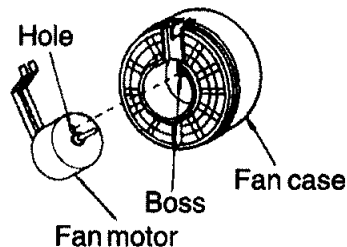

NOTE
 When replacing the fan motor, align the boss of the fan case with the hole of the fan motor.

Step 2

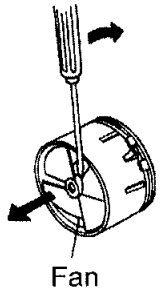

Step 3

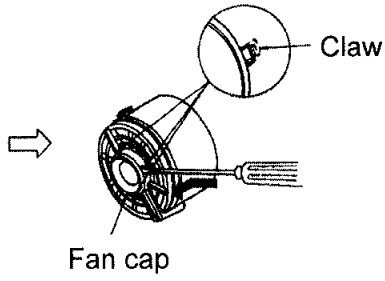

Step 2 Put a screwdriver at the root of the fan and remove it.

Step 3 Remove the fan cap.

Step 4

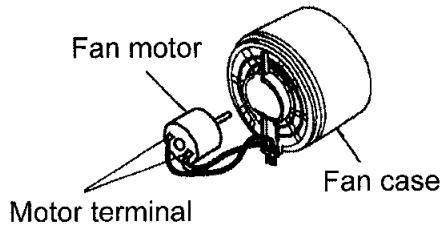

Step 4 Desolder the wires from the motor terminal and replace it with the new one.

7 Troubleshooting

This unit has test points on each circuit board block for use in troubleshooting.

7.1. Connection

Connect either a CD player, tape deck or AF oscillator to the input terminals of the unit.

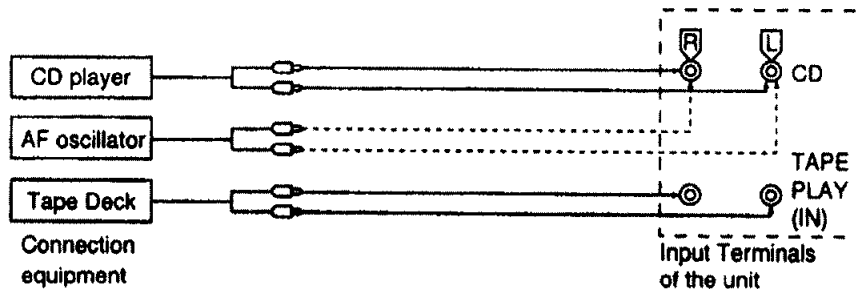

7.2. Required items

1. Testing with a CD player ----- Test disc (SZZP1054C / first program, 1 kHz, 0 dB)
2. Testing with a tape deck ----- Test tape (QZZCLA / 315 Hz, 0 dB)
3. Testing with a AF oscillator ----- Set the output at 500 Hz, 200 mV
4. Oscilloscope (min. 10 MHz) ----- To measure the output waveform at the test points.

7.3. Test Procedure for Amplifier Circuit

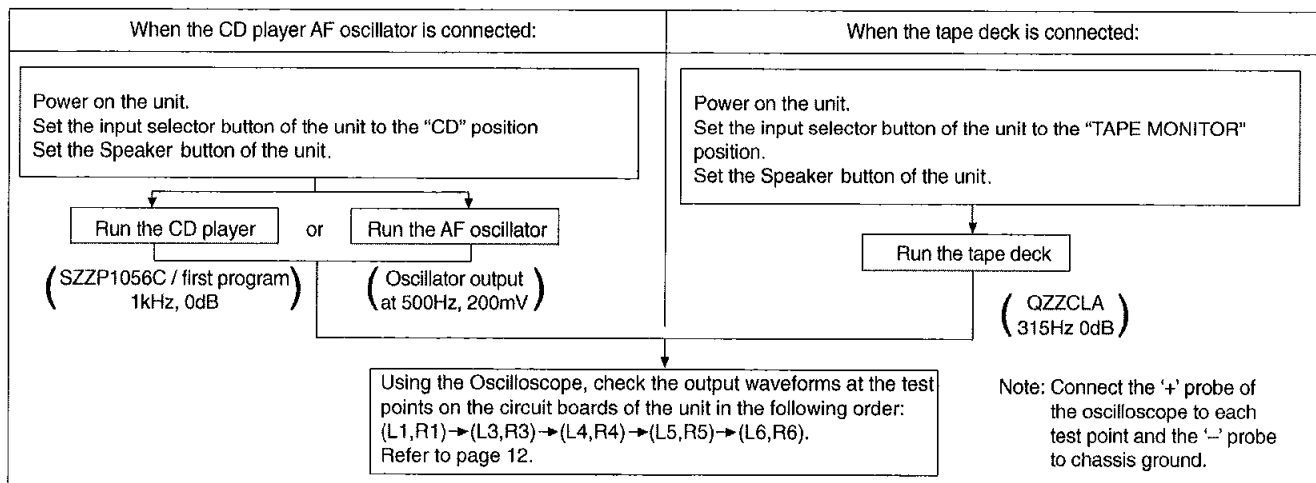

7.4. Test Points Positions of Amplifier Circuit

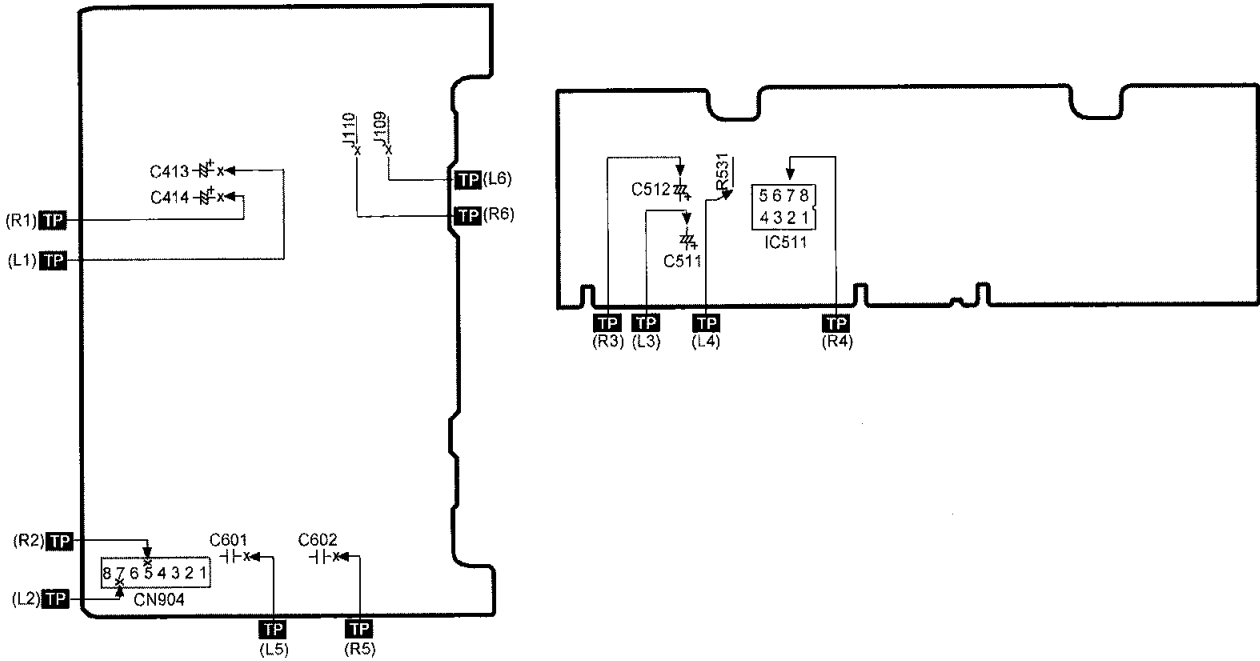

7.5. Normal Waveforms of Amplifier Circuit and Likely Faulty Blocks

TP	CD player	Tape deck	AF oscillator	Likely faulty block if the normal waveform shown at the left is not present.
L1/R1	 0.5msec 2V	 1msec 500mV	 1msec 500mV	Input selector block IC401 & area
L3/R3	 0.5msec 0.5mV	 1msec 100mV	 1msec 500mV	Master volume block VR501 & area
L4/R4	 0.5msec 5V	 1msec 500mV	 1msec 500mV	Tone control block IC511 & area
L5/R5	 0.5msec 2V	 1msec 500mV	 1msec 200mV	
L6/R6	 0.5msec 5V*	 1msec 1V*	 1msec 1V*	Main amplifier block IC601 & area

Measurement conditions.



Volume control (VR501), Tremble control (VR512) and Bass control (VR511) positions : ☉

* Volume control position (VR501) for these test : ☉

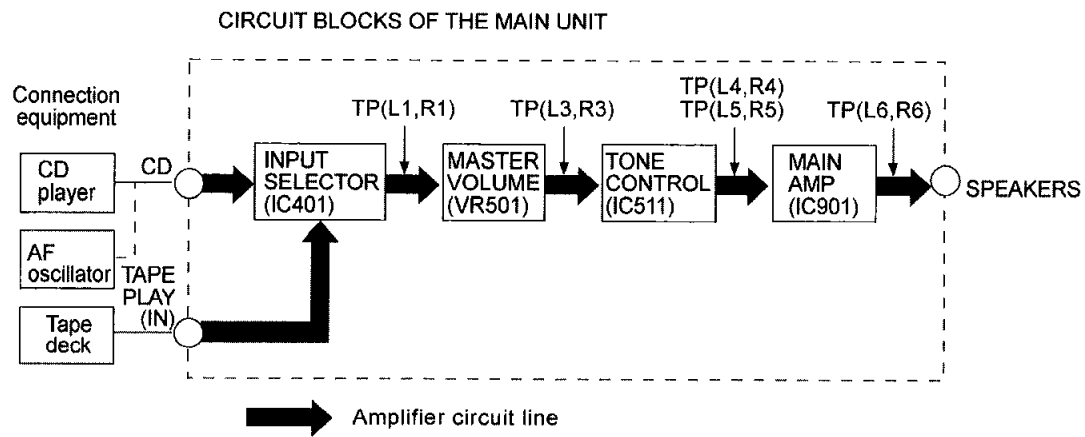
7.6. Circuit Blocks

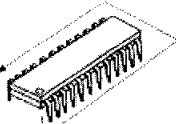
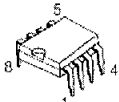
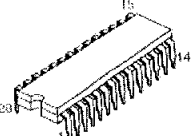
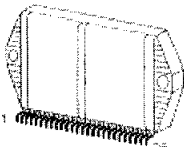
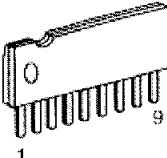

8 Type Illustrations of ICs, Transistors & Diodes

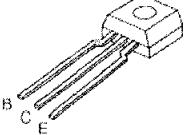
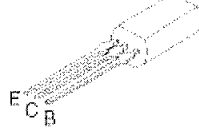
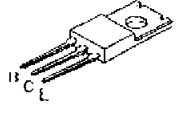
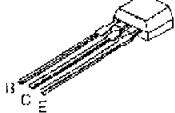
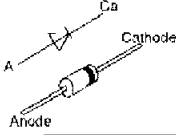
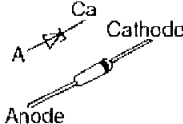
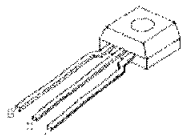
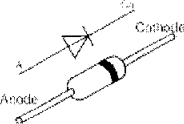
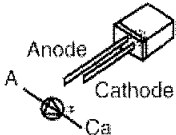
<p>LA1832A (24P) LC7218 (24P) LC72721N (22P)</p> 	<p>AN6558F M5218AP UPC4570C</p> 	<p>TC9163AN</p> 	<p>RSN3305-P</p> 	<p>BA6218</p> 	<p>M38B53M4055F</p> 
<p>2SC3311ARTA</p> 	<p>2SB621ARTA 2SC3940AQSTA</p> 	<p>2SB1548PQAU 2SD2374PQAU</p> 	<p>RVTDTA143XST RVTDTC114YST RVTDTA114YST 2SA933SSTA</p> 	<p>1N5402BM21 SB360L6508 MA167ATA</p> 	
<p>MTZJ16CTA MTZJ3R9ATA MTZJ4R7BTA MTZ5R1BTA MTZJ6R2BTA MTZJ6R8BTA</p>	<p>MTZJ7R5CTA MTZJ24DTA</p> 	<p>2SA1309ARTA 2SC2785FETA 2SC2787LTA 2SD1915FTA 2SC1740SSTA UN421FTA</p> 	<p>RVD1SS133TA 1SR35200TB MA700ATA 1SS291TA MA165TA</p> 		
<p>LN846RPH</p> 					

9 Terminal Functions of ICs





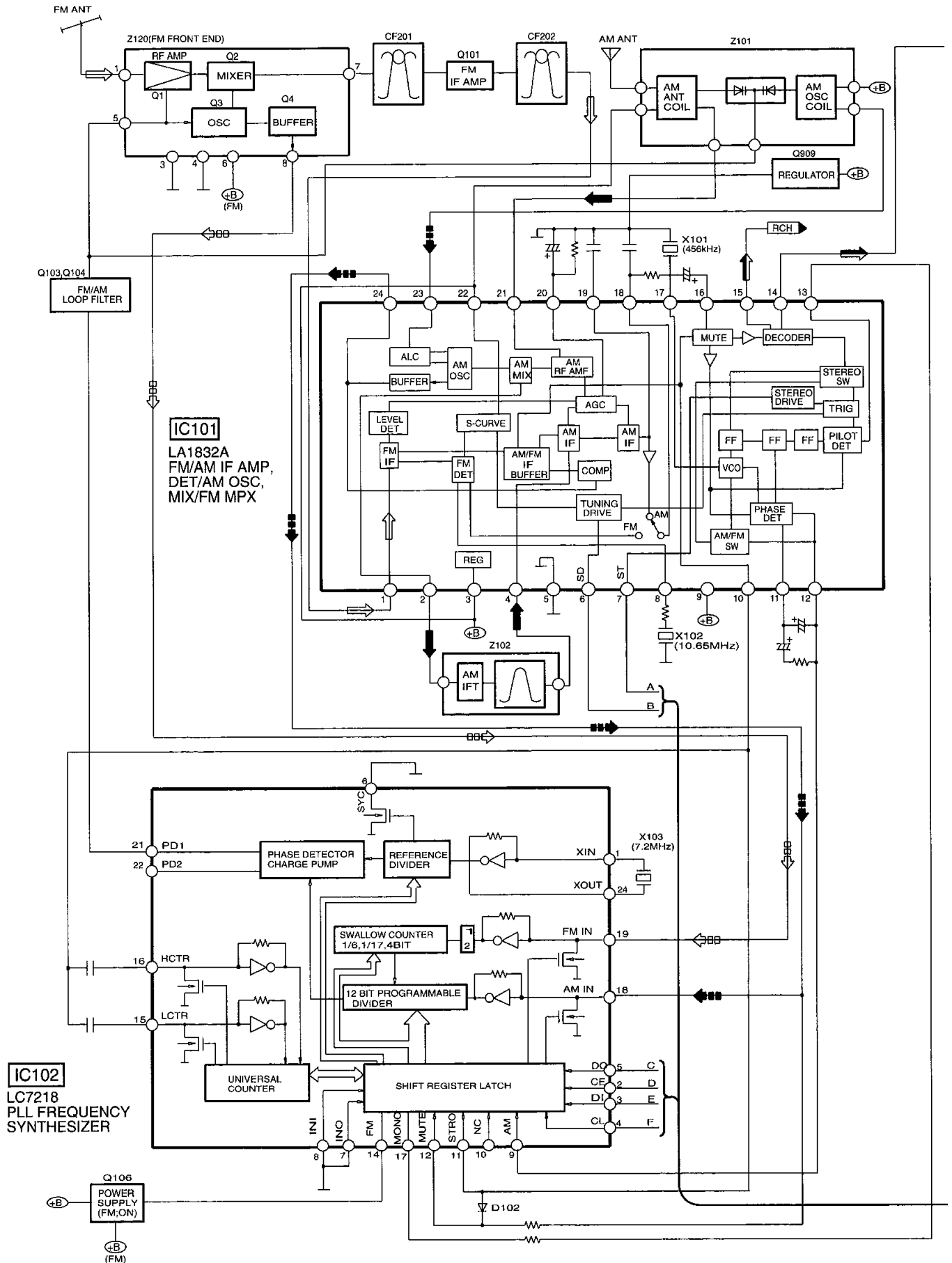

• IC901 (M38B53M3061F) System Microprocessor

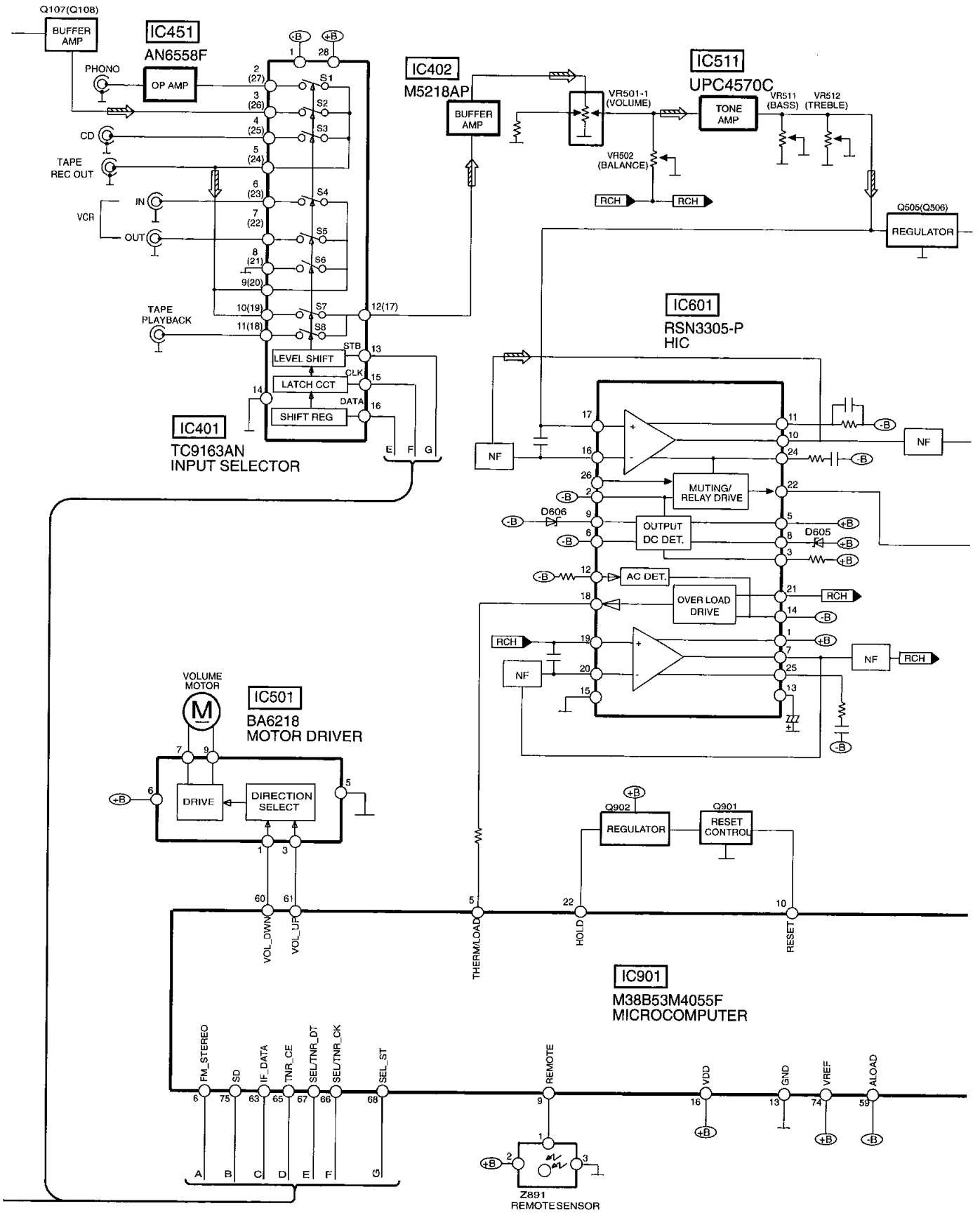
Pin No.	Mark	I/O	Function
1~3	KEY4~KEY2	I	Key Input 4~2
4	KEY 1	I	Key Input 1
5	THERM/OVLD2	I	Thermal/Over load input 2
6	FMST	I	Stereo signal detect terminal
7	6 CH_ST	O	Wake up timer LED
8	RDS_ST	I	No connection
9	REMOTE	I	Remote control terminal
10	RESET	-	Reset detect terminal
11	RDS_CK	I	No connection
12	RDS_DT	I	Control of RDS IC (DT) data signal
13	GND	-	GND terminal
14	XIN	I	Crystal oscillator terminal input (4 MHz)
15	XOUT	O	Crystal oscillator terminal output (4 MHz)
16	VDD	-	Power supply terminal +5V
17	SFC5	O	No connection
18	SFC4	O	No connection
19	SFC3	I	No connection
20	SFC2	I	No connection
21	SFC1	I	No connection
22	HOLD	I	Blackout detection terminal
23	STANDBY_LED	I	No connection
24	FAN_STOP	I	No connection
25	RELAY	O	Relay control output
26	TV/VCR2	O	No connection
27	LIMMITER	O	Power limiter control output
28	Vee	-	Power supply for FL driver
29	S/C_SP	O	Surround/Center speaker control output
30	SP_B	O	Speaker B control output
31	SP_A	O	Speaker A control output
32	AF_MUTE	O	Muting control output
33~48	SEG16~ SEG1	O	FL segment signal output
49~58	DEG1~ DEG10	O	FL digit signal output
59	INIT_IN	I	Diode input initial settings
60	VOL_DOWN	O	Volume control output (Down)
61	VOL_UP	O	Volume control output (Up)
62	LOUDNESS	O	ABS control output
63	IF_DATA	I	Serial data signal
64	REC_MUTE	O	Record mute control
65	TNR_CE	O	Tuner control (CE) chip enable signal
66	SEL/TNR_CK	O	Selector/Tuner (CK) clock signal
67	SEL/TNR_DT	O	Selector/Tuner (DT) data signal
68	SEL_ST	O	Selector control terminal
69	OSD_ST	O	MMD control terminal
70	SURR/OSD_CK	O	Surround control (CK) clock signal
71	SURR/OSD_DT	O	Surround control (DT) data signal
72	SURR_CE	O	Surround control (CE) chip enable signal
73	AVSS	-	GND for A-D converter
74	VREF	-	Reference voltage for A-D converter
75	SD	I	SD signal detect input
76	AC3_LED	I	No connection
77	HELP_LED	O	No connection
78	VIDEO_DET	I	No connection
79	VIDEO_B	O	Video selector control output B
80	VIDEO_A	O	Video selector control output A

10 Block Diagram





- NOTES:
-  FM SIGNAL LINE
 -  FM OSC SIGNAL LINE
 -  AM SIGNAL LINE
 -  AM OSC SIGNAL LINE
 -  MAIN SIGNAL LINE
 -  FM/AM SIGNAL LINE
- () indicates Pin No. Right Channel.

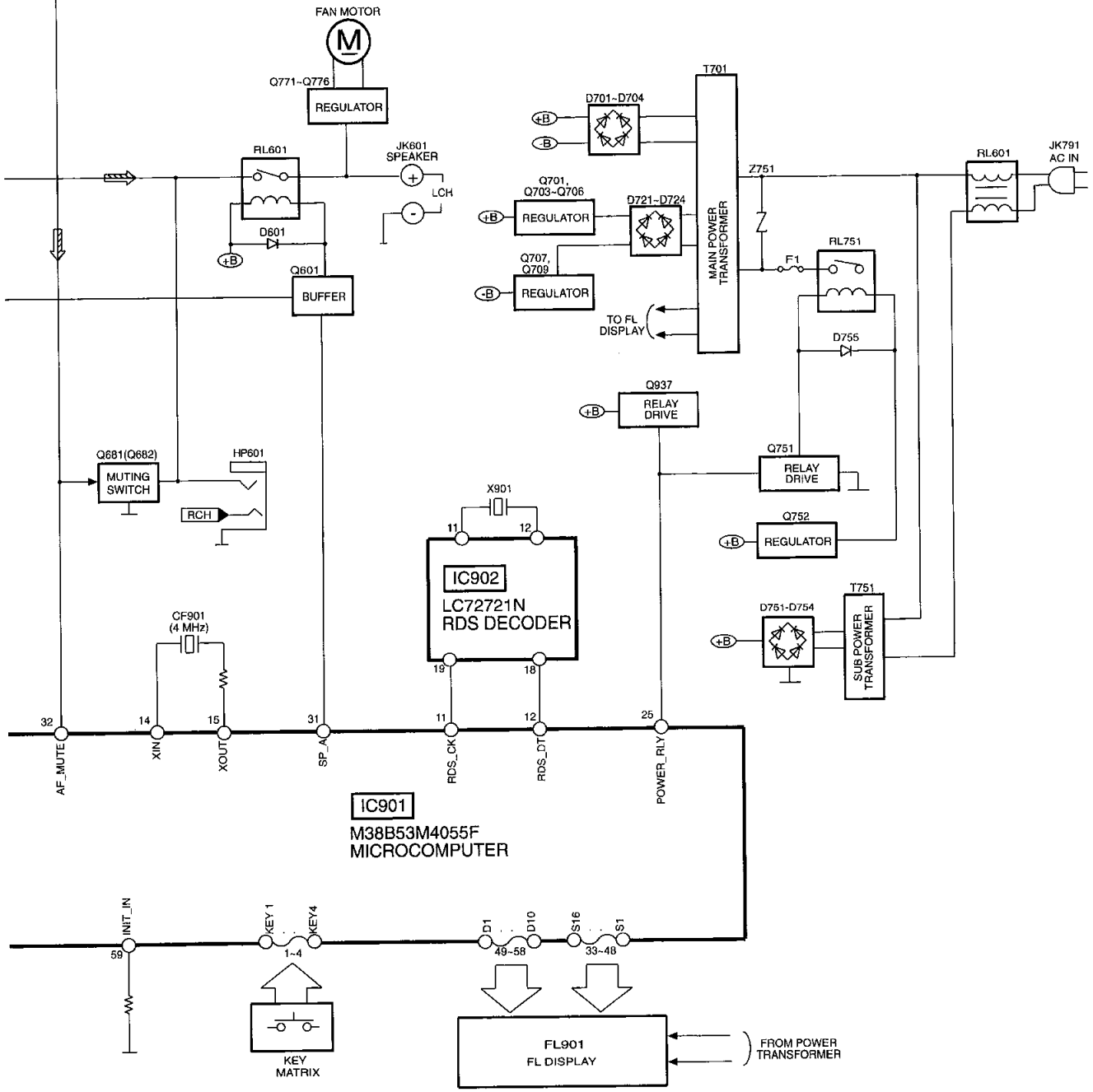

11 Schematic Diagram

(All schematic diagrams may be modified at any time with the development of new technology.)

Notes:

S946	Power Switch
S947	Phone Switch
S948	Muting Switch
S950	FM Mode Switch
S951	Band Switch
S952	Tuning Down Switch
S953	Tuning Up Switch
S955	Memory Switch
S956	Channel Down Switch
S957	Channel Up Switch
S960	Tuner Switch
S961	CD Switch
S962	Tape Monitor Switch
S964	VCR Switch
S970	Search Switch
S971	EON Switch
S972	PTY Select Up Switch
S973	PTY Select Down Switch
S974	Display Mode Switch
S980	Speakers A/B/OFF Switch

- The voltage value and waveforms are the reference voltage of this unit measured by DC electronic voltmeter (high impedance) and oscilloscope on the basis of chassis. Accordingly, there may arise some error in voltage values

and waveforms depending upon the internal impedance of the tester or the measuring unit.

< > ...FM
() ...AM

• Importance safety notice:

Components identified by \triangle mark have special characteristics important for safety. Furthermore, special parts which have purposes of fire-retardant (resistors), high-quality sound (capacitors), low-noise (resistors), etc. are used. When replacing any of components, be sure to use only manufacturer's specified parts shown in the parts list.

Caution!

IC, LSI and VLSI are sensitive to static electricity.

Secondary trouble can be prevented by taking care during repair.

- Cover the parts boxes made of plastics with aluminium foil.
- Put a conductive mat on the work table.
- Ground the soldering iron.
- Do not touch the pins of IC, LSI or VLSI with fingers directly.

SCHMATIC DIAGRAM-1

— : +B Line
 ⇨ : FM Signal Line
 ⇨ : FM/AM Signal Line
 ⇨ : AM Signal Line
 ⇨ : FM OSC Signal Line
 ⇨ : AM OSC Signal Line

A TUNER CIRCUIT

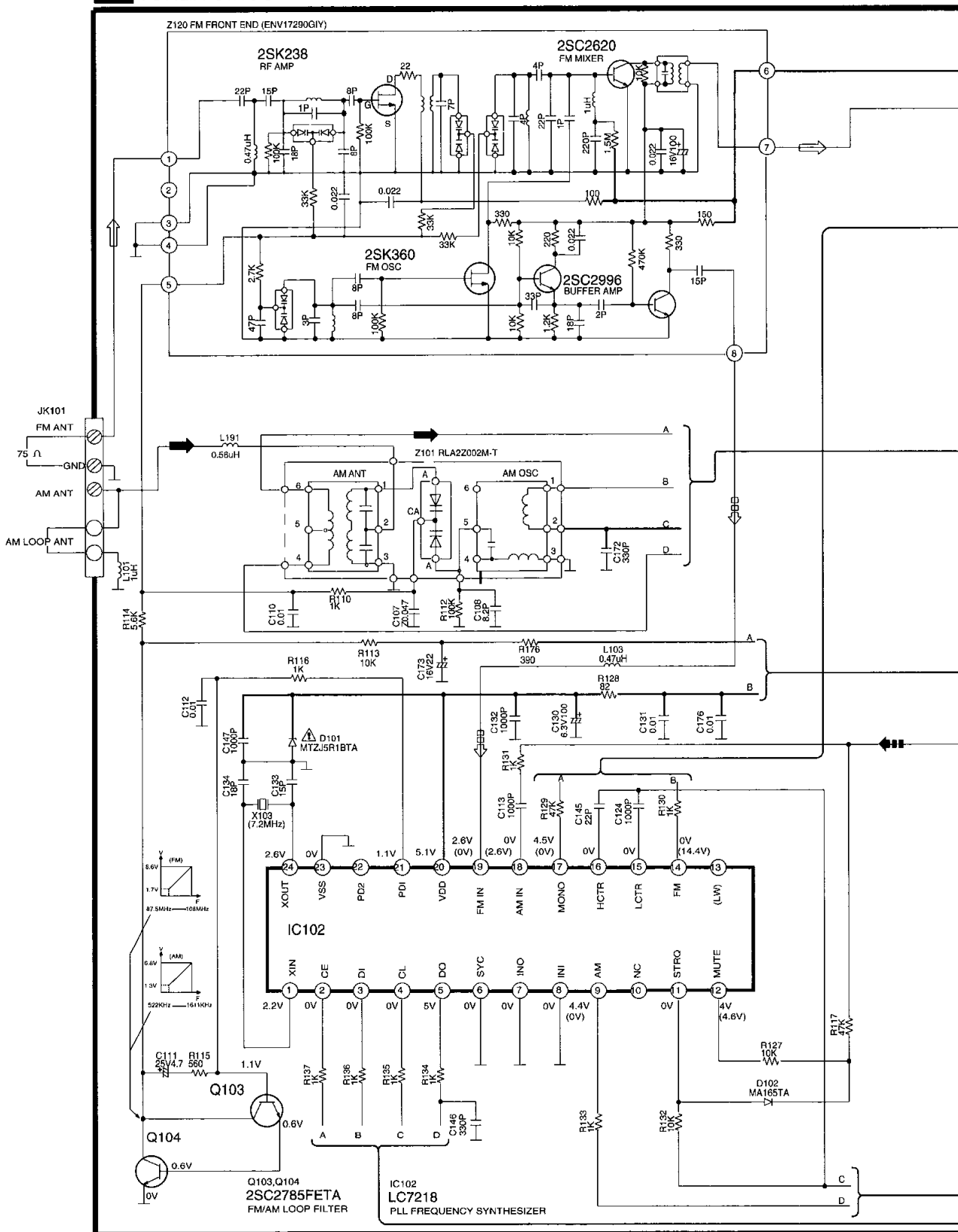

SCHEMATIC DIAGRAM-2

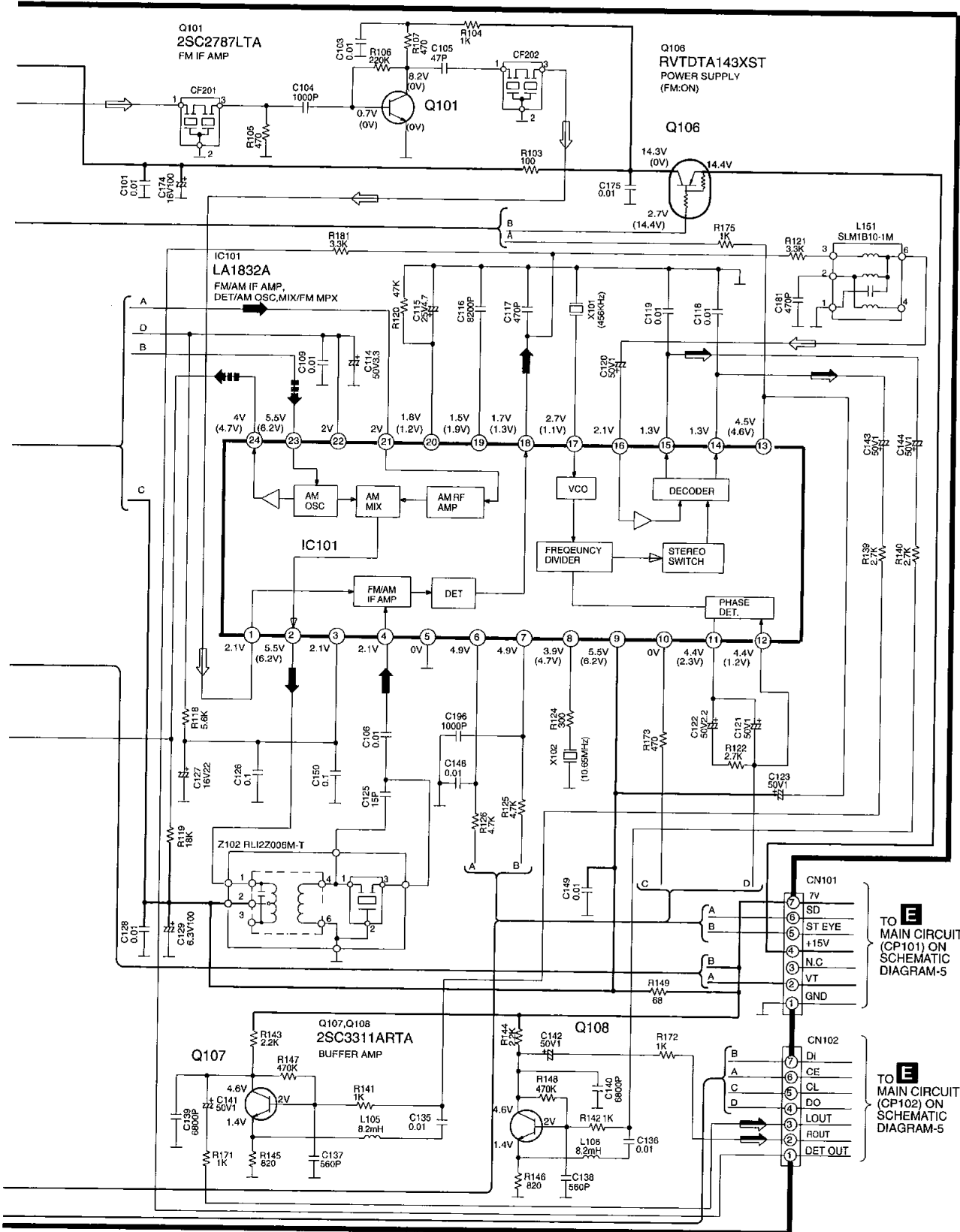
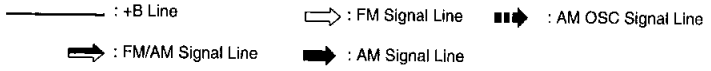

SCHEMATIC DIAGRAM - 3

→ : Main Signal Line ——— : +B Line - - - : -B Line

B PANEL CIRCUIT

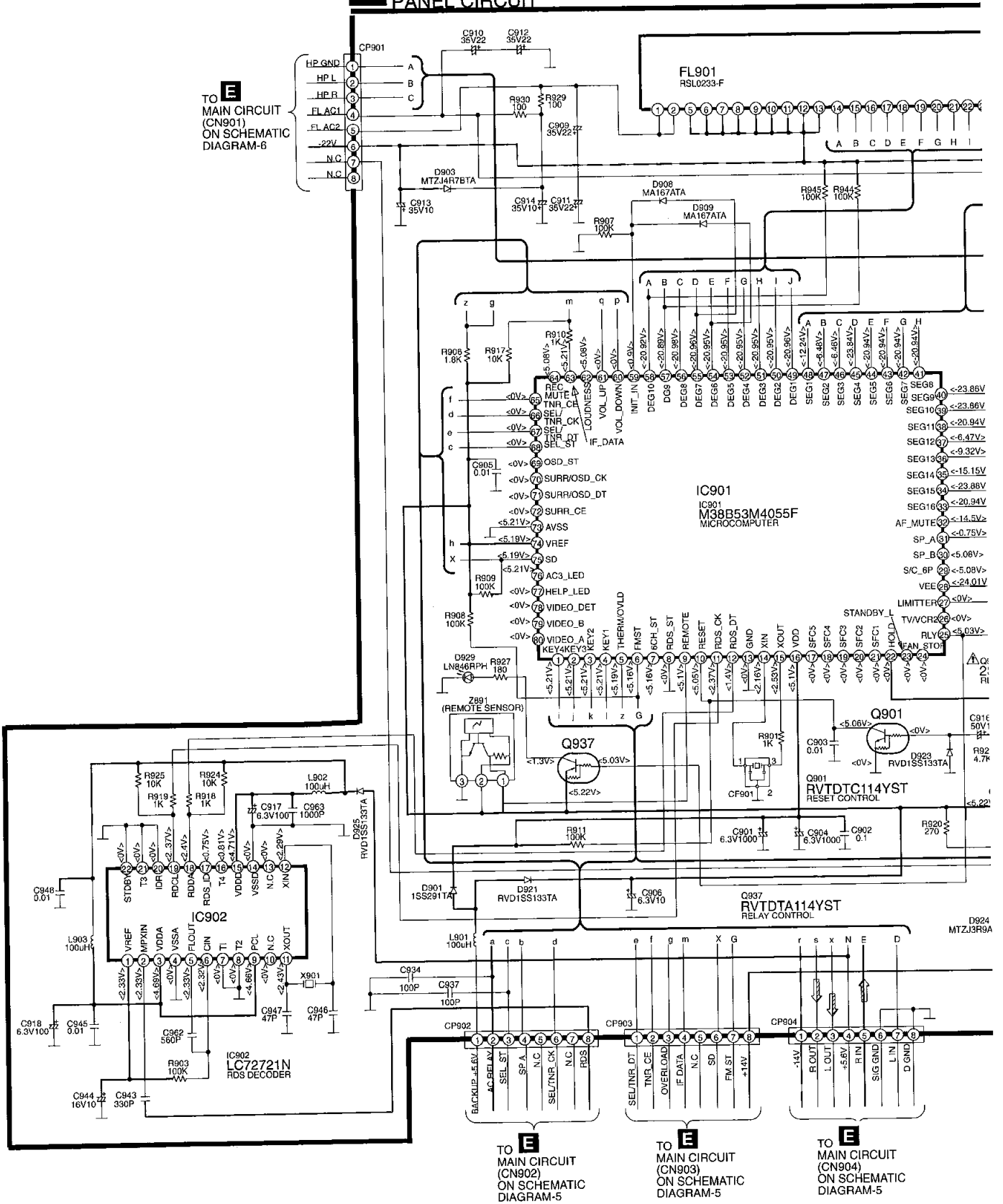

SCHEMATIC DIAGRAM - 4



: Main Signal Line — : +B Line - - - : -B Line

C VOLUME CIRCUIT

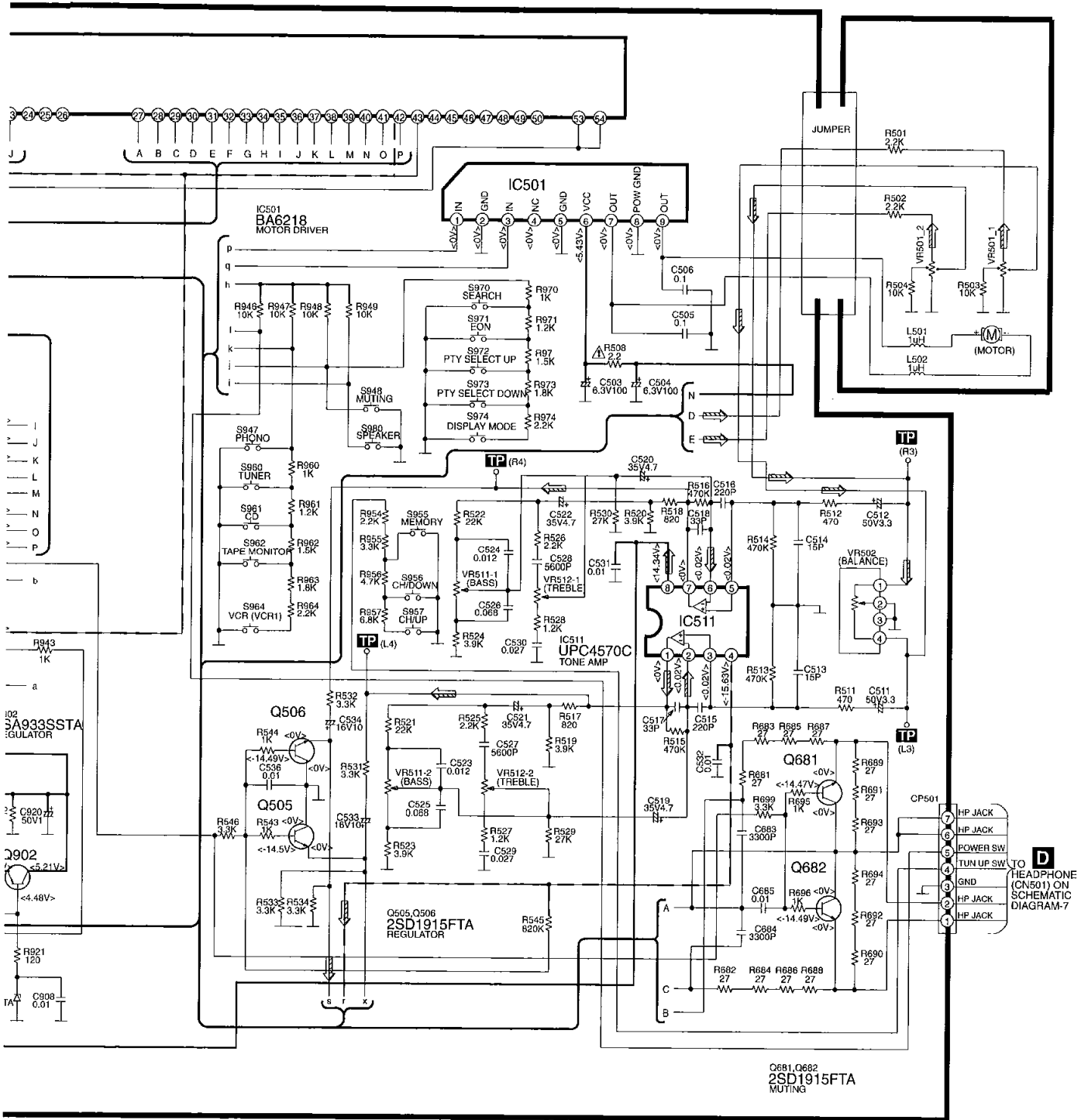

SCHEMATIC DIAGRAM - 5

— : +B Line - - - : -B Line ⇨ : Main Signal Line ⇨ : FM/AM Signal Line

E MAIN CIRCUIT

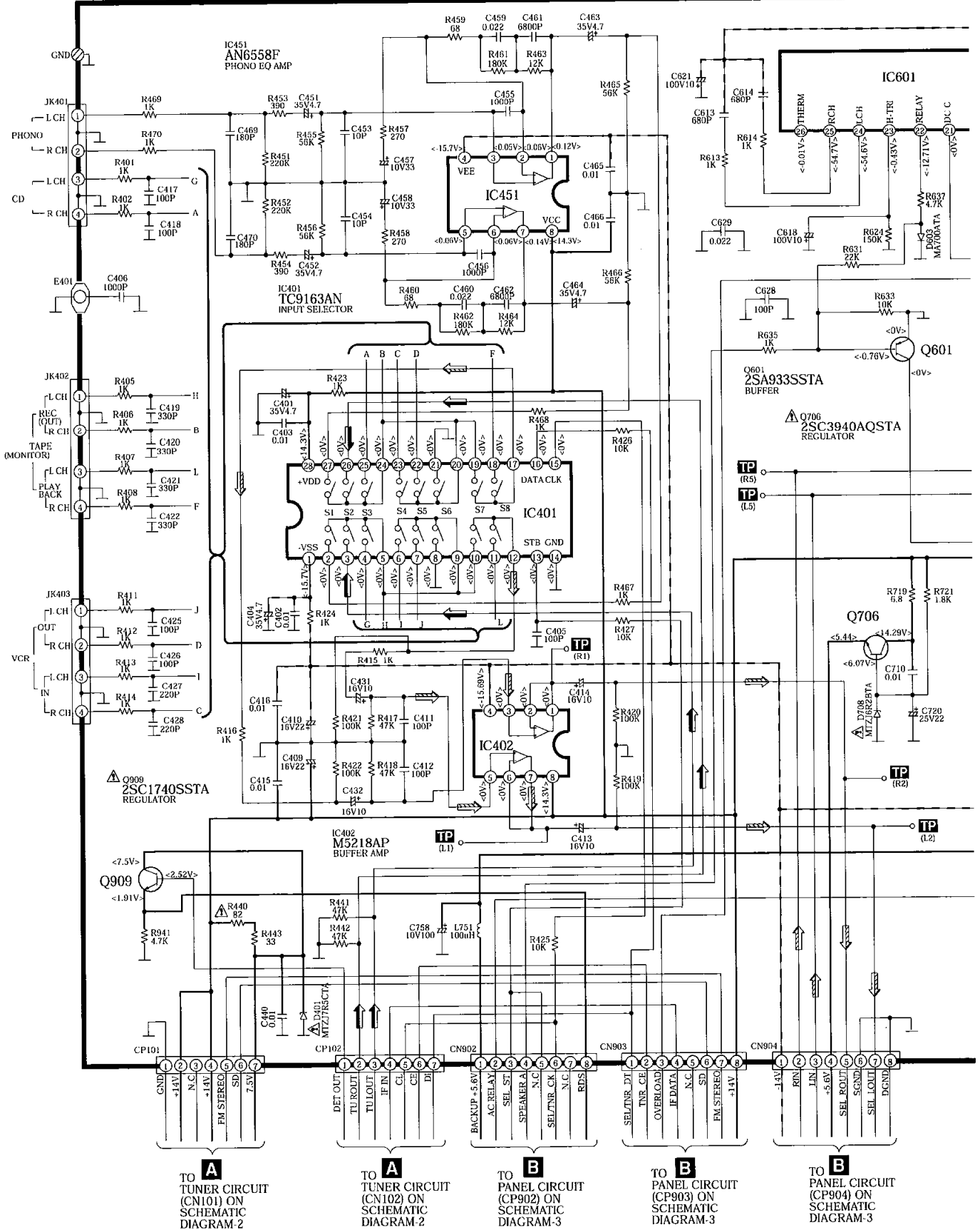

SCHEMATIC DIAGRAM - 6

— : +B Line

- - - : -B Line

⇨ : Main Signal Line

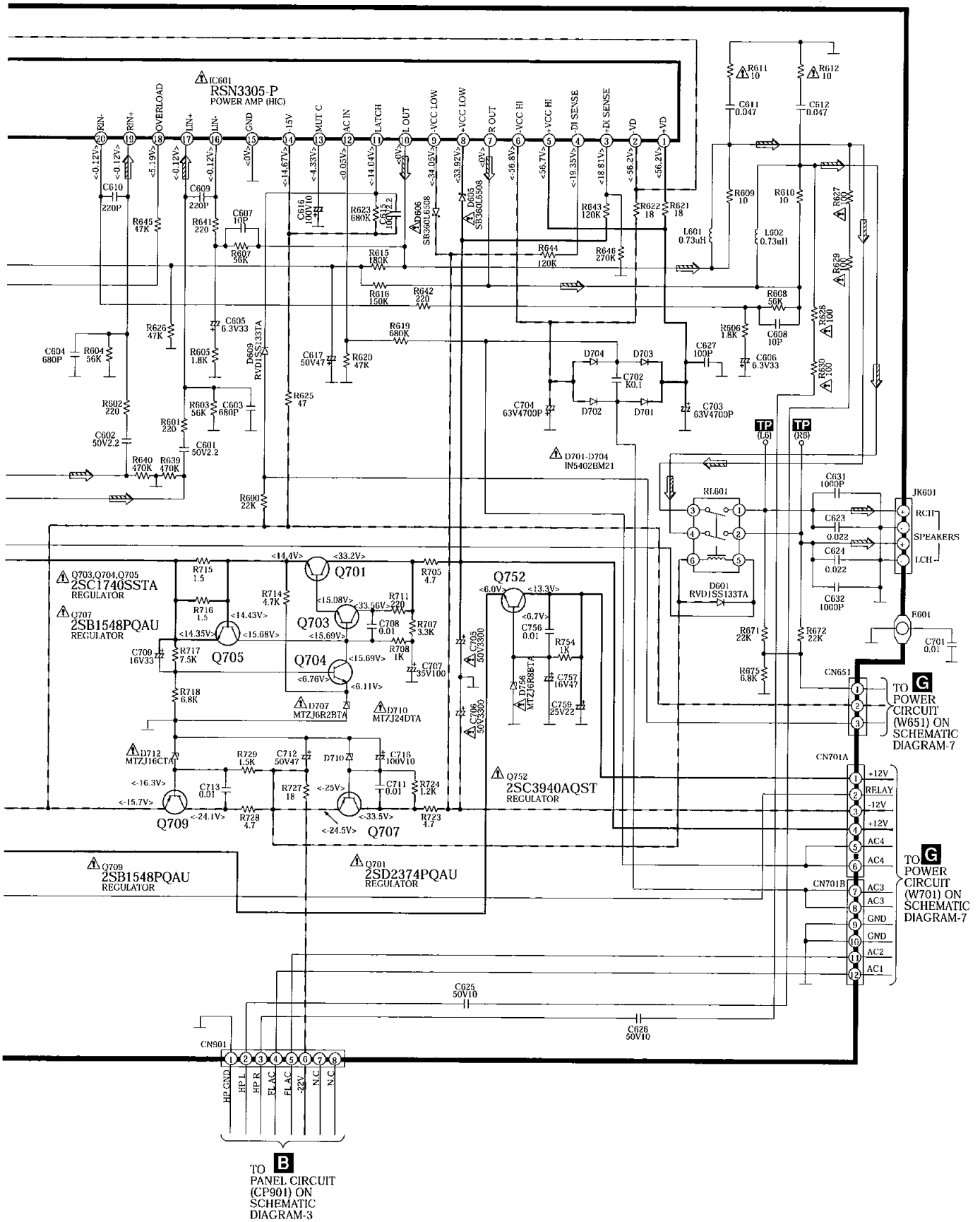

SCHMATIC DIAGRAM - 7

— +B Line - - - -B Line

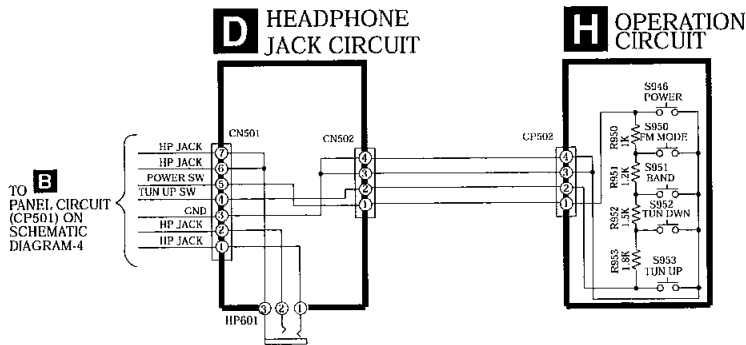
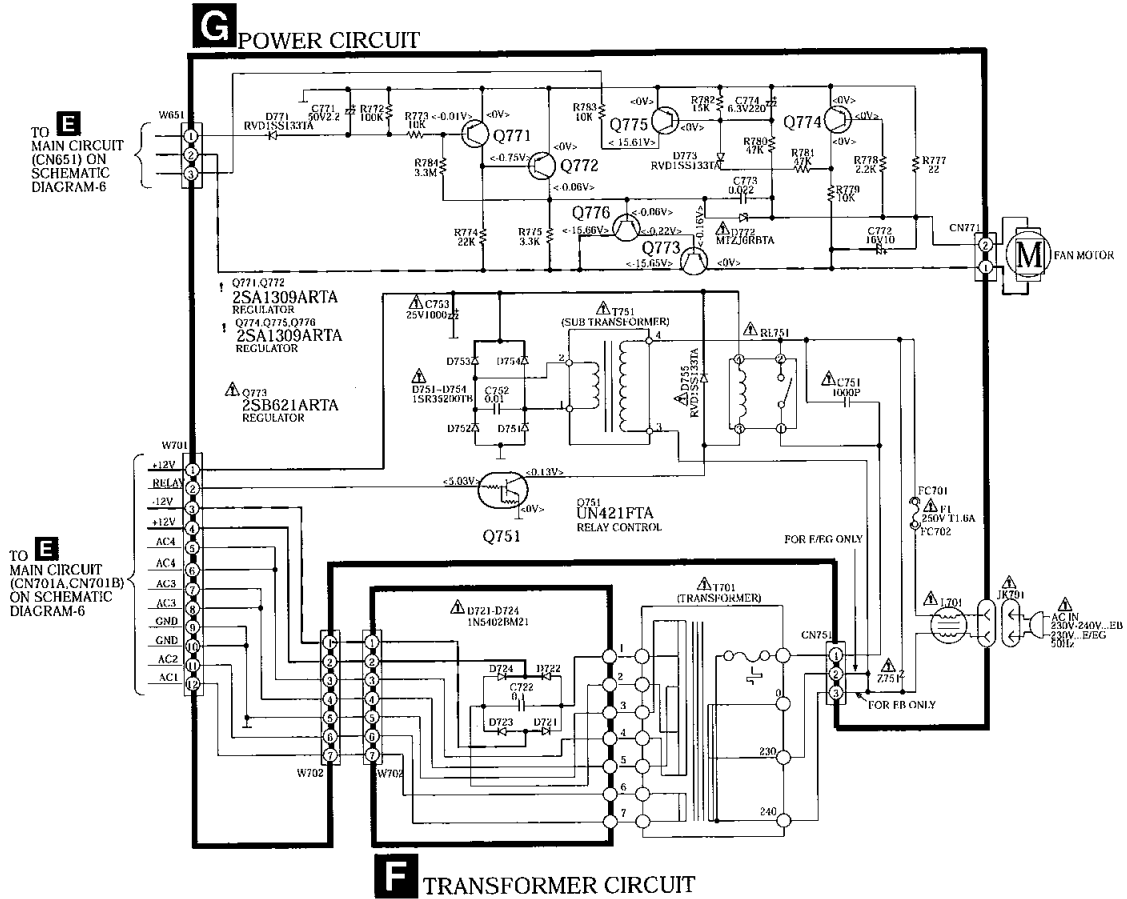

12 Printed Circuit Board

A B C D E F G

1
2
3
4
5
6
7
8
9

A TUNER P.C.B. (REP2254C-T)

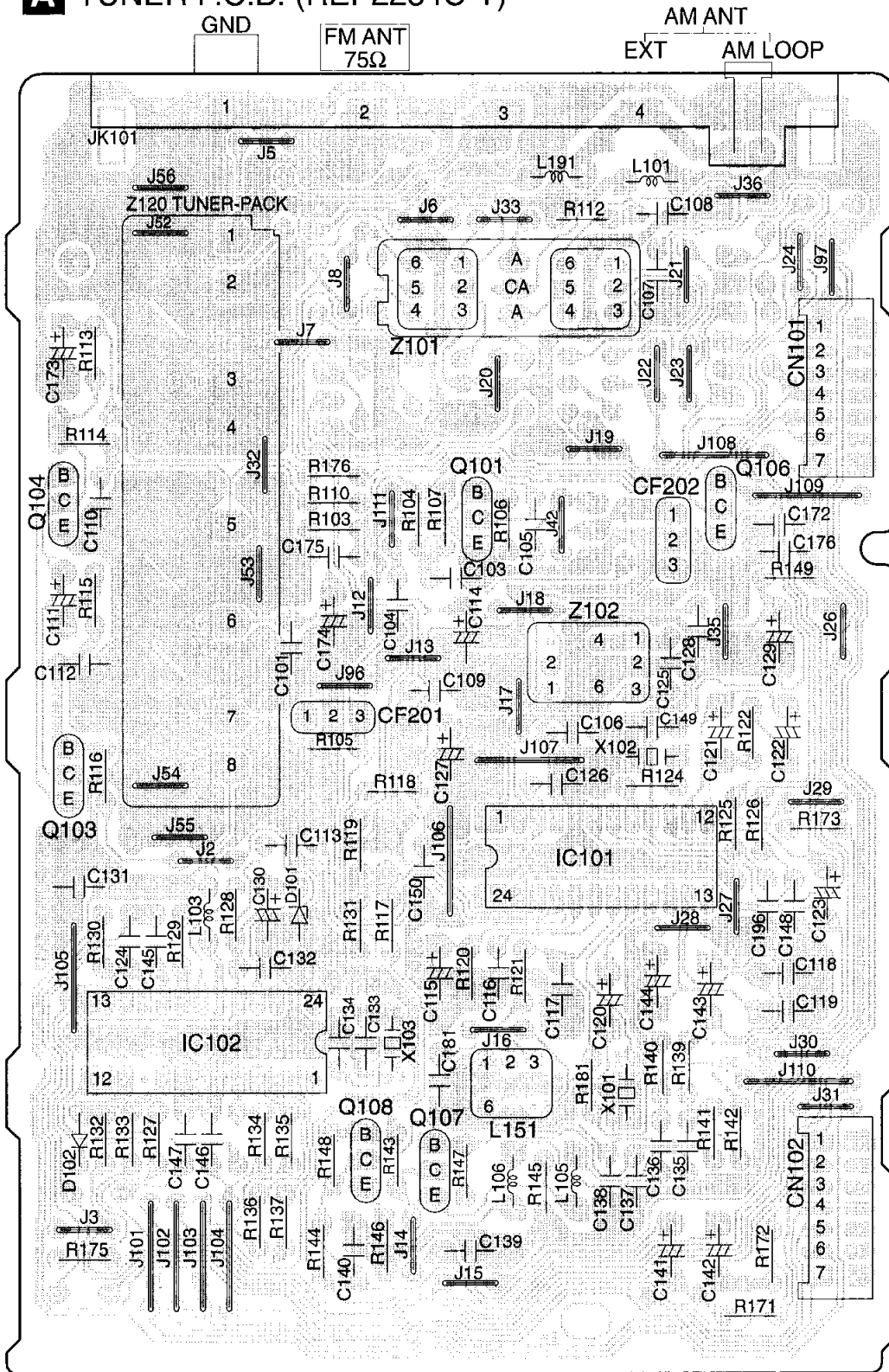

A B C D E F G

1 **C** VOLUME P.C.B.
(REP2650C-S)

B PANEL P.C.B.
(REP2650C-S)

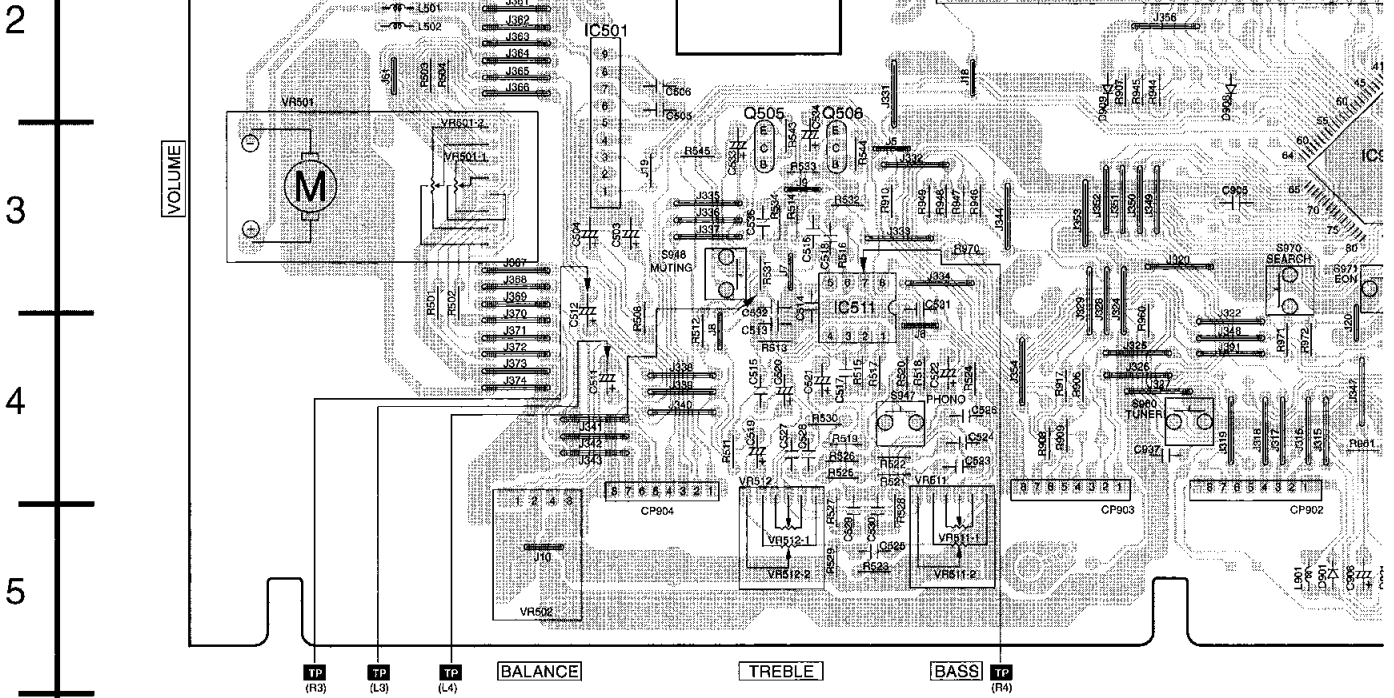

6 **D** HEADPHONE JACK P.C.B. (REP2650C-S)

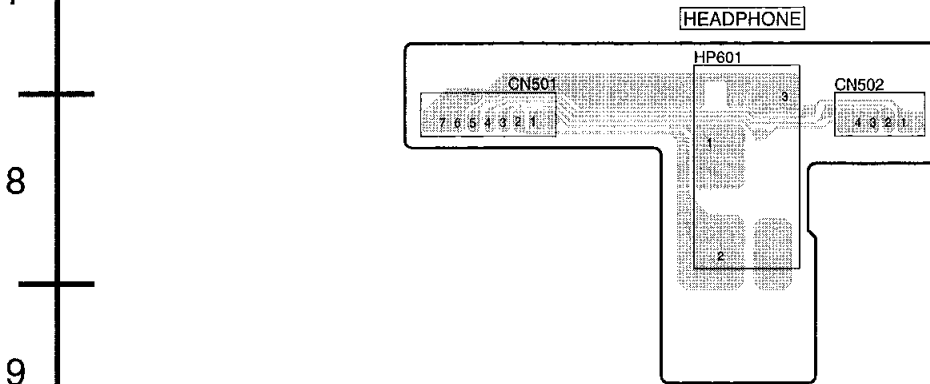

G H I J K L M

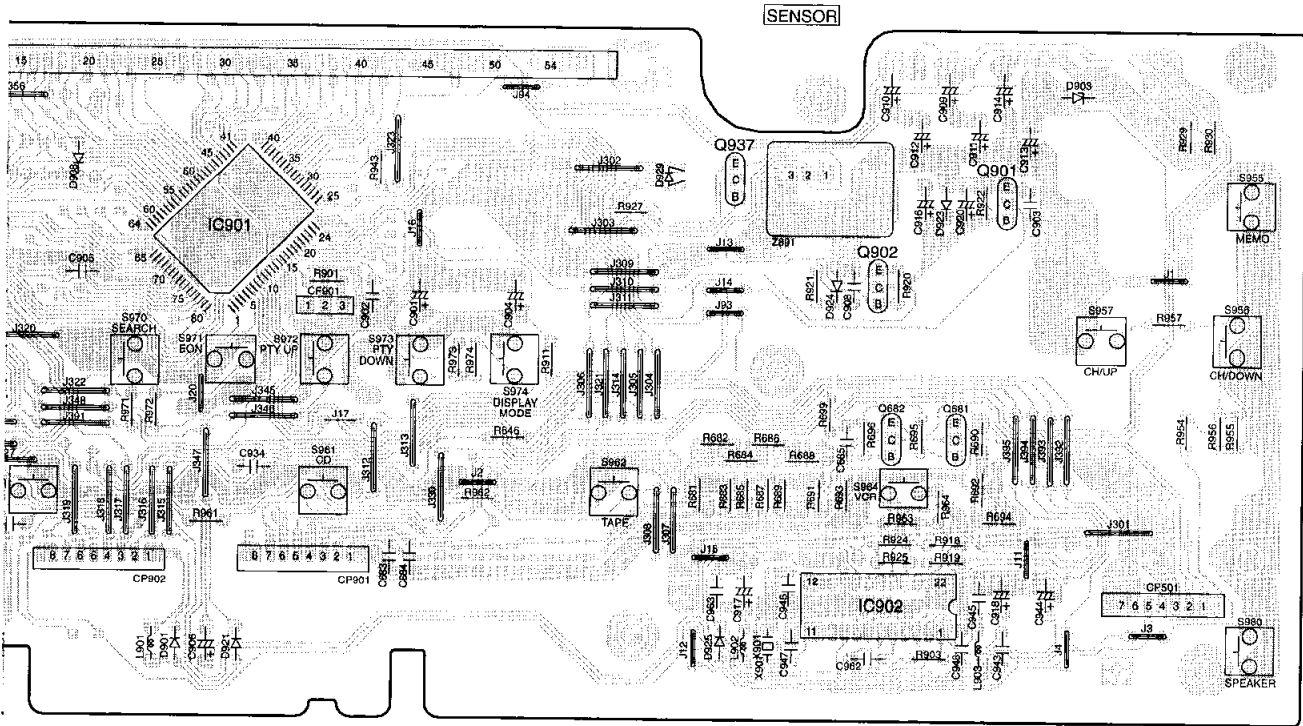

H OPERATION P.C.B. (REP2650C-S)

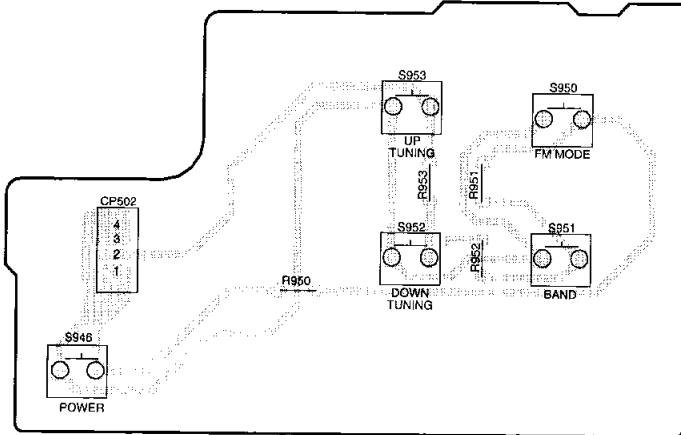

A B C D E F G

1 **E** MAIN P.C.B. (REP2251E-M)

2
3
4
5
6
7
8
9

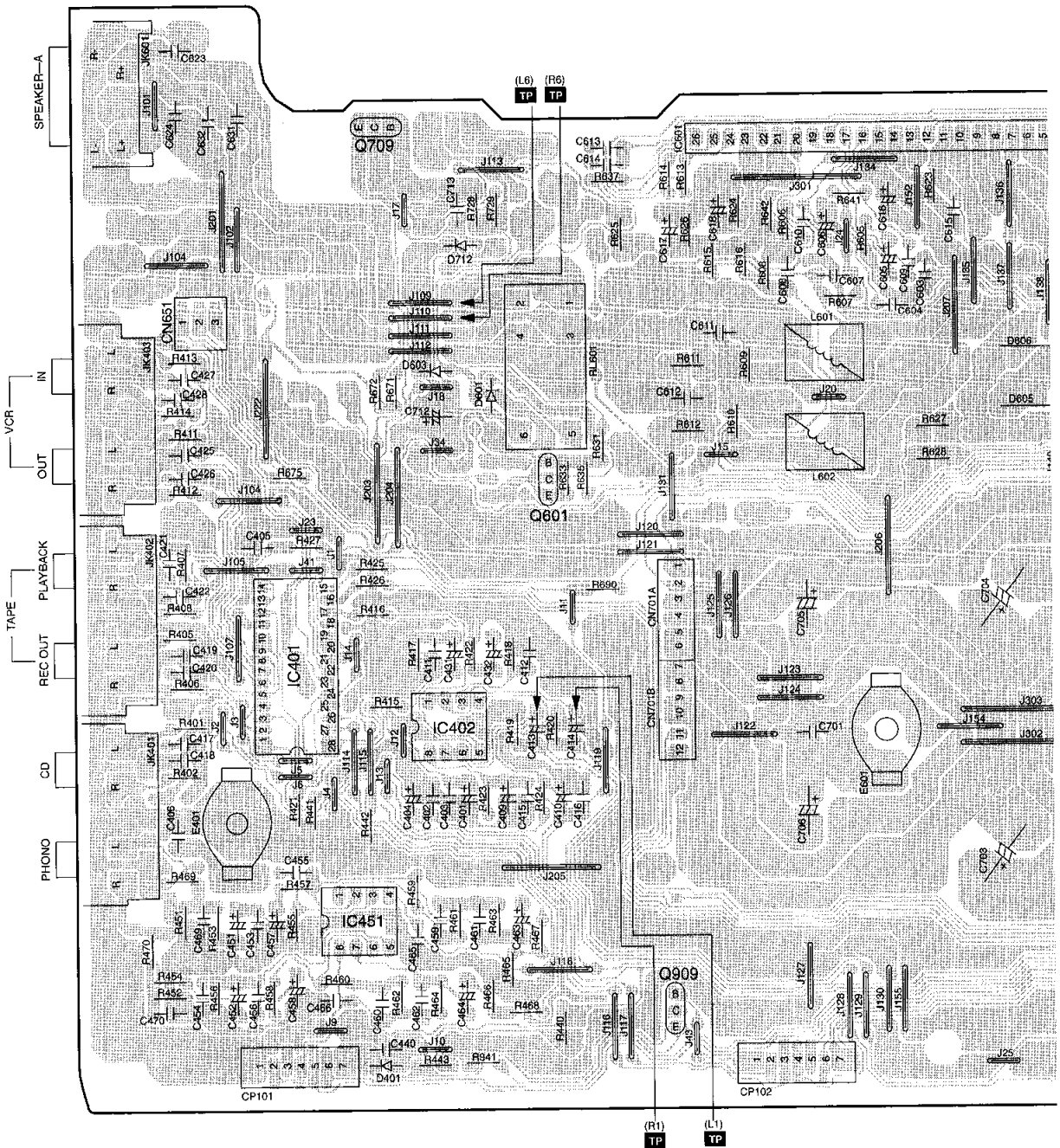

G H I J K L M

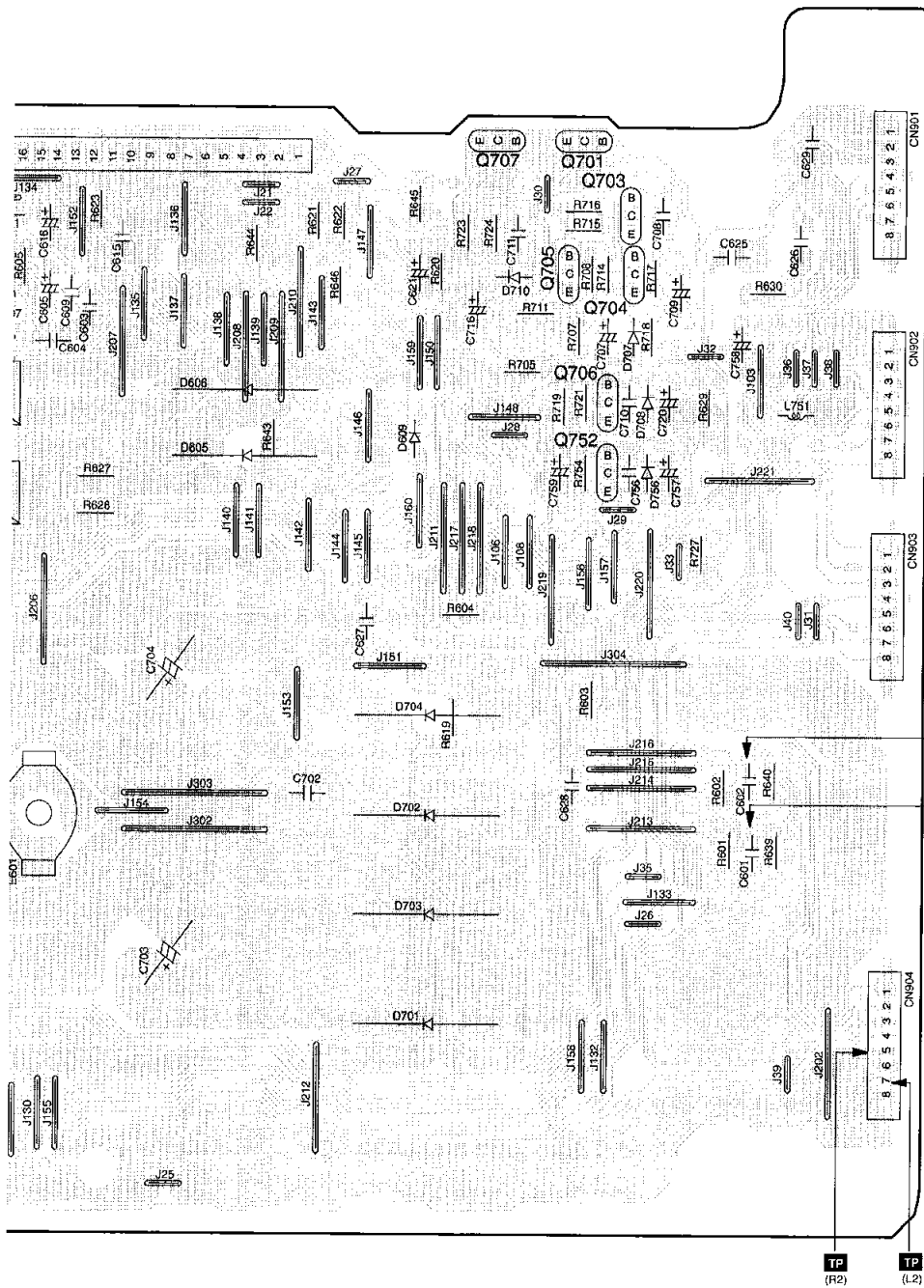

A B C D E F G

1
2
3
4
5
6
7
8
9

G POWER SUPPLY P.C.B.
(REP2253B-P...EB)

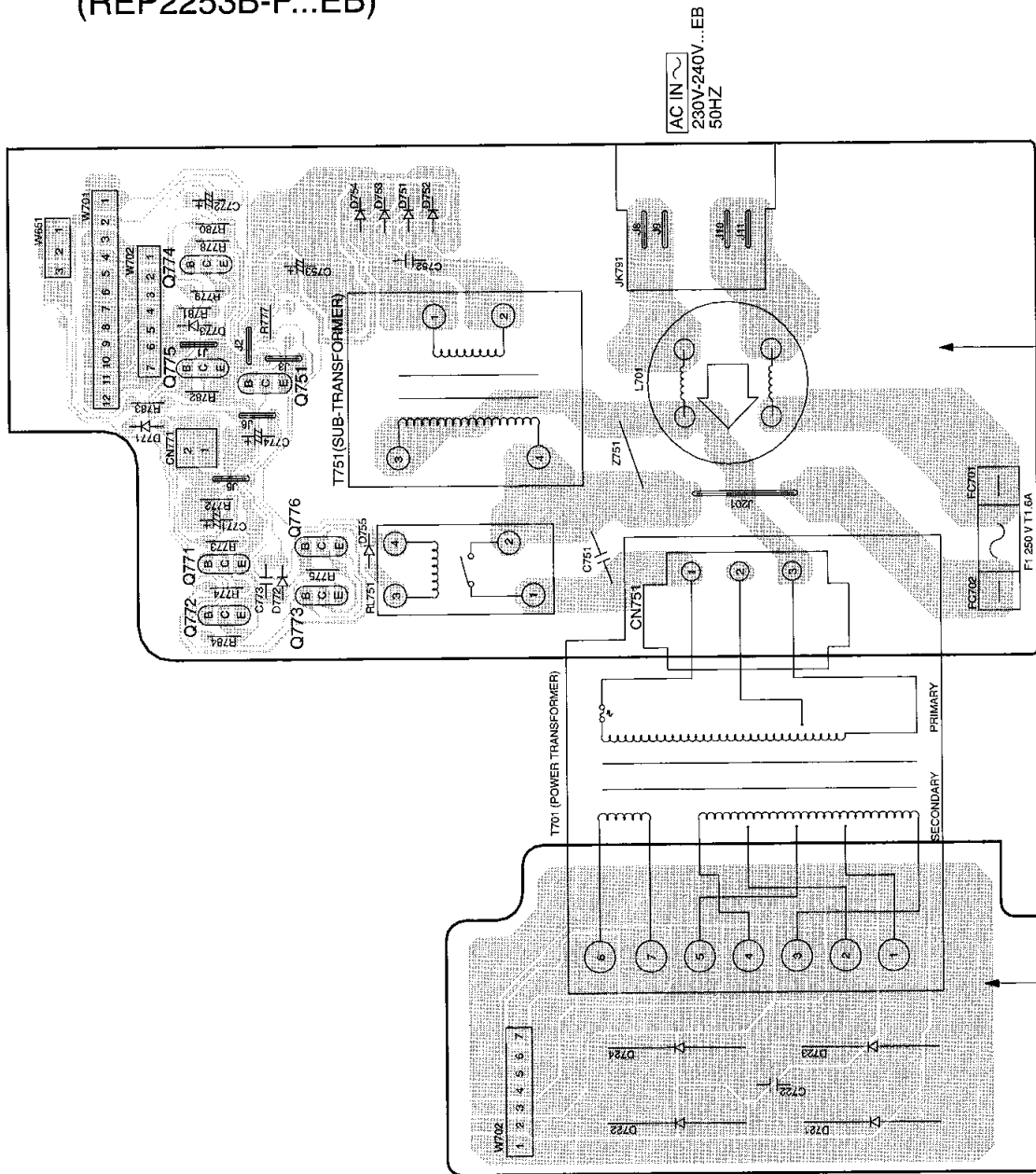

F TRANSFORMER P.C.B.
(REP2251E-M)

A B C D E F G

1 **G** POWER SUPPLY P.C.B.
(REP2253C-P...E/EG)

2

3

4

5

6

7

8

9

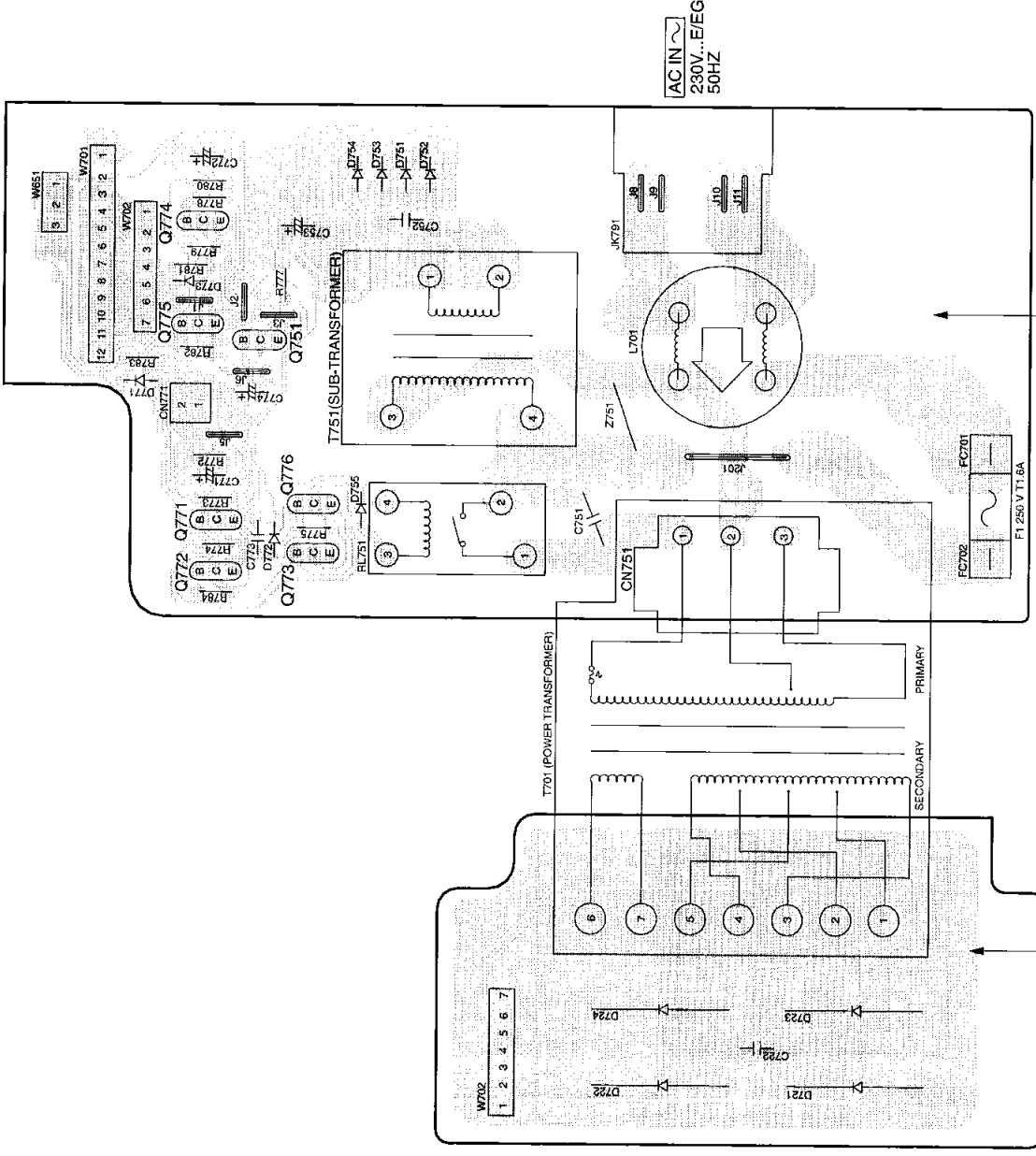

F TRANSFORMER P.C.B.
(REP2251E-M)

13 Wiring Connection Diagram

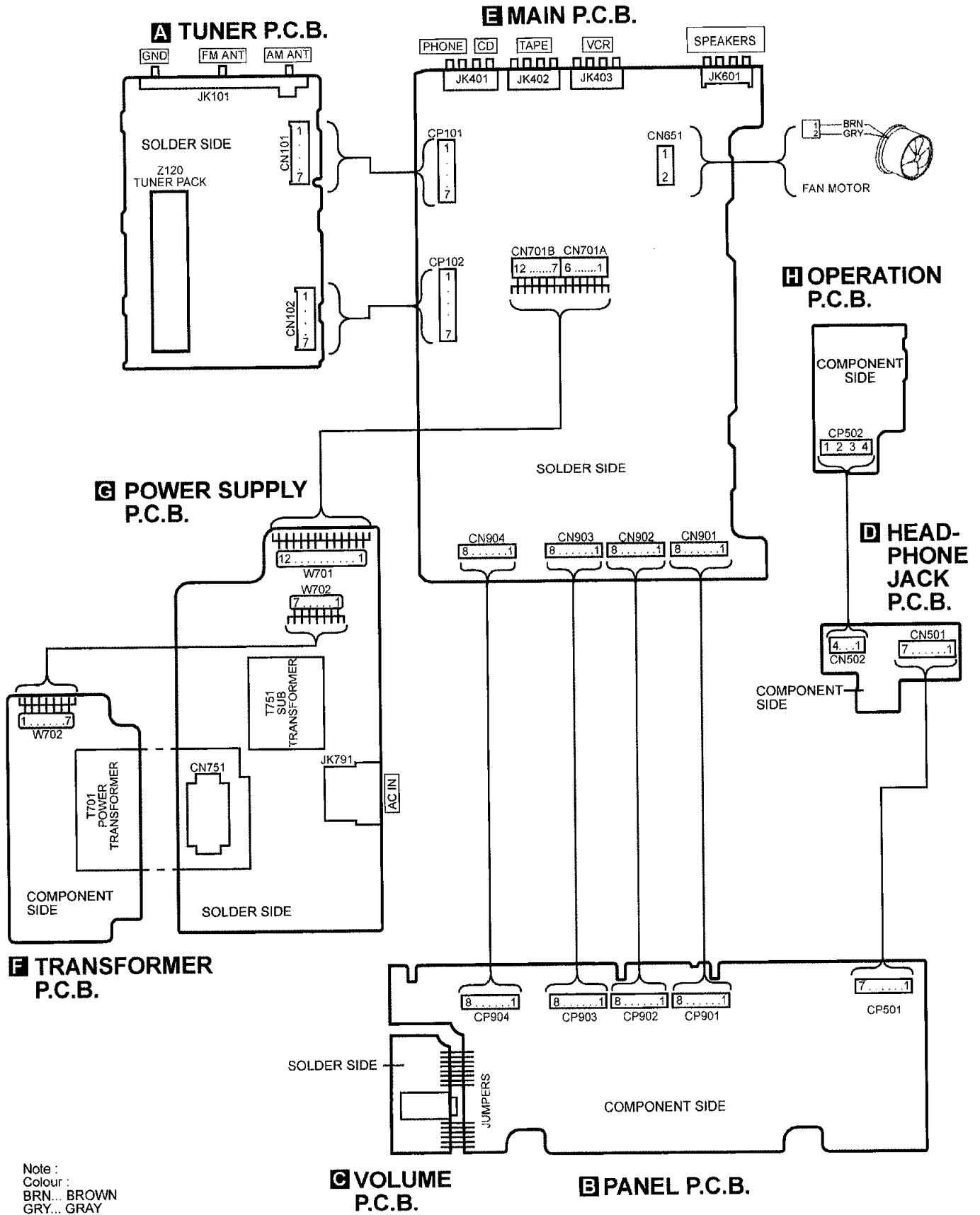

Note :
Colour :
BRN... BROWN
GRY... GRAY

14 Parts Location and Replacement Parts List

Notes:

- Important safety notice:

Components identified by \triangle mark have special characteristics important for safety.

Furthermore, special parts which have purposes of fire-retardant (resistors), high-quality sound (capacitors), low-noise (resistors), etc. are used.

When replacing any of these components, be sure to use only manufacturers's specified parts shown in the parts list.

- The parenthesized indications in the Remarks column specify the areas or color. (Refer to the cover page for area or color.)

Parts without these indications can be used for all areas.

- Capacitor values are in microfarad (μ F) unless specified otherwise, P=Pico-farads(pF); Farads.

- Resistance values are in ohms, unless specified otherwise, 1K=1,000(ohms).

- The marking (RTL) indicates that the Retention Time is limited for this item. After the discontinuation of this assembly in production, the item will continue to be available for a specific period of time. The retention period of availability is dependant on the type of assembly, and in accordance with the laws governing part and product retention. After the end of this period, the assembly will no longer be available.

- [M] indicates in the Remarks columns indicates parts that are supplied by **MESA**.

- The "(SF)" mark denotes the standard part.

- Remote Control Unit: Supply period for three years from terminal of production.

- Reference for O/I book languages are as follows :

Ar : Arabic

Cf : Canadian French

Cz : Czech

Da : Danish

Du : Dutch

En : English

Fr : French

Ge : German

It : Italian

Ko : Korean

Po : Polish

Ru : Russian

Sp : Spanish

Sw : Swedish

Co : Traditional Chinese

Cn : Simplified Chinese

14.1. Cabinet

14.1.1. Cabinet Parts Location

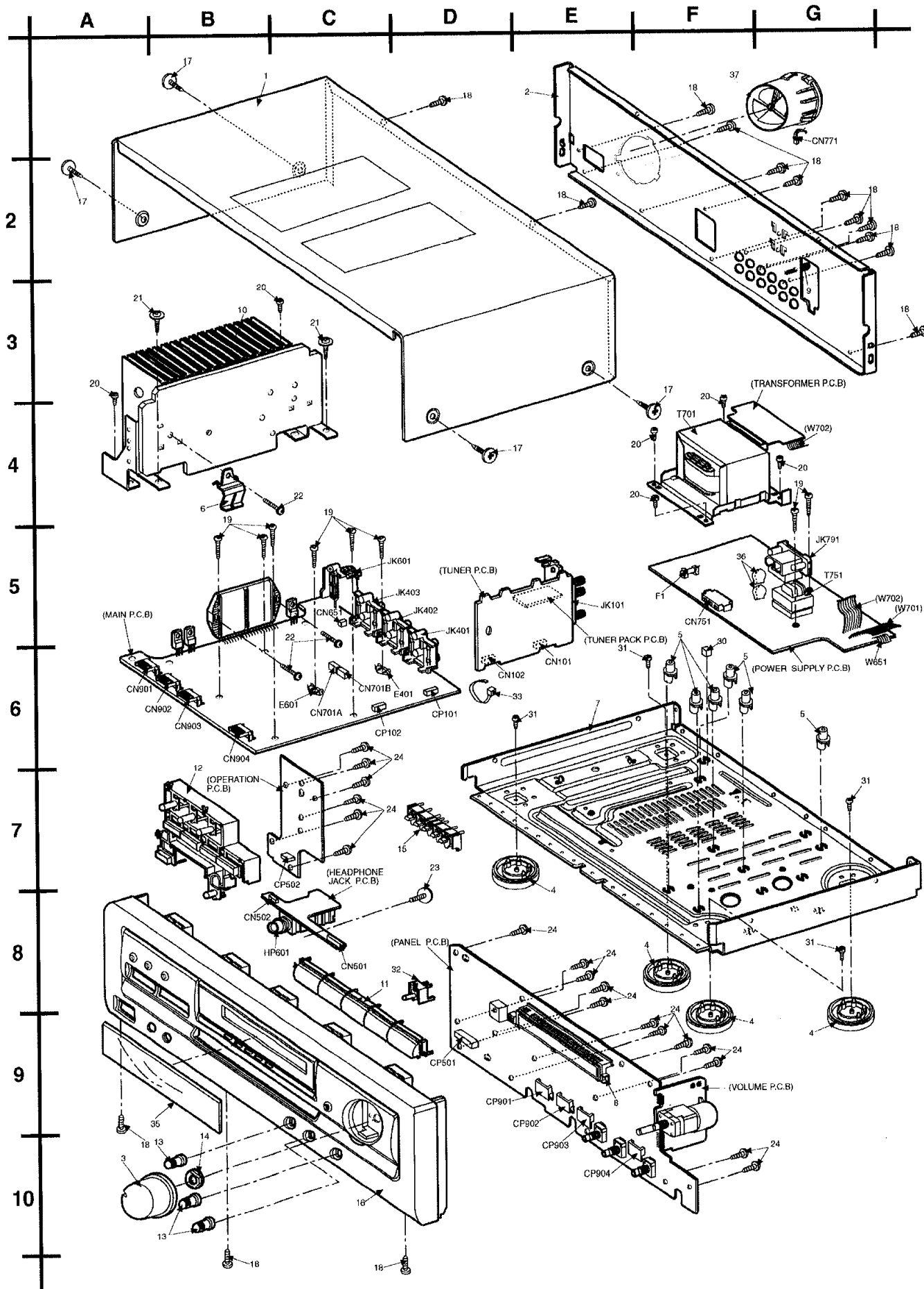

14.1.2. Cabinet Parts List

Ref. No.	Part No.	Part Name & Description	Remarks
		CABINET AND CHASSIS	
1	RKM0374B-K	TOP CABINET	[M]
2	RGR0178L-A	REAR PANEL	[M] EG E
2	RGR0178L-B	REAR PANEL	[M] EB
3	RGW0278-K	VOLUME KNOB	[M]
4	RKA0079-A	LEG UNIT	[M]
5	RKQ0089-J	PCB HOLDER	[M]
6	RMC0158-S	TRANSISTOR HOLDER	[M]
7	RMK0276	BOTTOM CHASSIS	[M]
8	RMN0372	FL HOLDER	[M]
9	SNE2123	EARTH TERMINAL	[M]
10	RXX0169	HEAT SINK UNIT	[M]
11	RGU1832-K	SELECTOR BUTTON	[M]
12	RGU1833-K	MODE BUTTON	[M]
13	RGW0244-1K	BASS TREBLE KNOB	[M]
14	RHN90001	M9 NUT	[M]

Ref. No.	Part No.	Part Name & Description	Remarks
15	RGU1835-K	RDS BUTTON	[M]
16	RFKGAEX140EK	FRONT PANEL ASS'Y	[M]
17	SNE2129-1	SCREW (CABINET)	[M]
18	XTBS3+8JFZ1	SCREW	[M]
19	XTB3+20JFZ	SCREW	[M]
20	XTB3+8FFZ	SCREW	[M]
21	XTWS3+8T	SCREW	[M]
22	XTW3+15T	SCREW	[M]
23	RHD26016	SCREW (PHONE JACK)	[M]
24	XTBS26+10J	SCREW	[M]
30	RKQ0213-K	PCB SUPPORT	[M]
31	XTB3+6G	SCREW (FOOT)	[M]
32	RGU1834-K	MUTING BUTTON	[M]
33	SHR301	WIRE CRAMPER	[M]
35	RKW0612A-Q1	FL WINDOW (PRINTING)	[M]
36	RMZ0339	ZNR COVER	[M]
37	RYQ0173-K	FAN UNIT	[M]

14.2. Electrical Parts List

Ref. No.	Part No.	Part Name & Description	Remarks
		P.C.B.	
	REP2251AE-M	MAIN P.C.B.	[M] RTL
	REP2254C-T	TUNER P.C.B.	[M] RTL
	REP2650C-S	VOLUME P.C.B./PANEL P.C.B./HEADPHONE JACK P.C.B./OPERATION P.C.B.	[M] RTL
	REP2253B-P	POWER SUPPLY P.C.B./ TRANSFORMER P.C.B.	[M] RTL EB
	REP2253C-P	POWER SUPPLY P.C.B./ TRANSFORMER P.C.B.	[M] RTL E EG
		INTEGRATED CIRCUITS	
IC101	LA1832A	IC IF/MPX	[M]
IC102	LC7218	IC PLL	[M]
IC401	TC9163AN	IC SELECTOR	[M]
IC402	M5218AP	IC BUFFER AMP	[M]
IC451	AN6558F	IC OP AMP	[M]
IC501	BA6218	IC MOTOR DRIVER	[M]
IC511	UPC4570C	IC TONE CONTROL	[M]
IC601	RSN3305-P	IC HIC	[M] △
IC901	M38B53M4055F	IC MICOM	[M]
IC902	LC72721N	IC RDS	[M]
		TRANSISTORS	
Q101	2SC27871TA	TRANSISTOR	[M]
Q103	2SC2785FETA	TRANSISTOR	[M]
Q104	2SC2785FETA	TRANSISTOR	[M]
Q106	RVTDTA143XST	TRANSISTOR	[M]
Q107	2SC3311ARTA	TRANSISTOR	[M]
Q108	2SC3311ARTA	TRANSISTOR	[M]
Q505	2SD1915FTA	TRANSISTOR	[M]
Q506	2SD1915FTA	TRANSISTOR	[M]
Q601	2SA933SSTA	TRANSISTOR	[M]
Q681	2SD1915FTA	TRANSISTOR	[M]
Q682	2SD1915FTA	TRANSISTOR	[M]
Q701	2SD2374PQAU	TRANSISTOR	[M] △
Q703	2SC1740SSTA	TRANSISTOR	[M] △
Q704	2SC1740SSTA	TRANSISTOR	[M] △
Q705	2SC1740SSTA	TRANSISTOR	[M] △
Q706	2SC3940AQSTA	TRANSISTOR	[M] △
Q707	2SB1548PQAU	TRANSISTOR	[M] △
Q709	2SB1548PQAU	TRANSISTOR	[M] △
Q751	UN421FTA	TRANSISTOR	[M]
Q752	2SC3940AQSTA	TRANSISTOR	[M] △
Q771	2SA1309ARTA	TRANSISTOR	[M] △
Q772	2SA1309ARTA	TRANSISTOR	[M] △
Q773	2SB621ARTA	TRANSISTOR	[M] △
Q774	2SA1309ARTA	TRANSISTOR	[M] △

Ref. No.	Part No.	Part Name & Description	Remarks
Q775	2SA1309ARTA	TRANSISTOR	[M] △
Q776	2SA1309ARTA	TRANSISTOR	[M] △
Q901	RVTDTA114YST	TRANSISTOR	[M]
Q902	2SA933SSTA	TRANSISTOR	[M] △
Q909	2SC1740SSTA	TRANSISTOR	[M] △
Q937	RVTDTA114YST	TRANSISTOR	[M]
		DIODES	
D101	MTZJ5R1BTA	DIODE	[M] △
D102	MA165TA	DIODE	[M]
D401	MTZJ7R5CTA	DIODE	[M] △
D601	RVD18S133TA	DIODE	[M]
D603	MA700ATA	DIODE	[M]
D605	SB360L6508	DIODE	[M] △
D606	SB360L6508	DIODE	[M] △
D609	RVD18S133TA	DIODE	[M]
D701	1N5402BM21	DIODE	[M] △
D702	1N5402BM21	DIODE	[M] △
D703	1N5402BM21	DIODE	[M] △
D704	1N5402BM21	DIODE	[M] △
D707	MTZJ6R2BTA	DIODE	[M] △
D708	MTZJ6R2BTA	DIODE	[M] △
D710	MTZJ24DTA	DIODE	[M] △
D712	MTZJ16CTA	DIODE	[M] △
D721	1N5402BM21	DIODE	[M] △
D722	1N5402BM21	DIODE	[M] △
D723	1N5402BM21	DIODE	[M] △
D724	1N5402BM21	DIODE	[M] △
D751	1SR35200TB	DIODE	[M] △
D752	1SR35200TB	DIODE	[M] △
D753	1SR35200TB	DIODE	[M] △
D754	1SR35200TB	DIODE	[M] △
D755	RVD18S133TA	DIODE	[M]
D756	MTZJ6R8BTA	DIODE	[M] △
D771	RVD18S133TA	DIODE	[M]
D772	MTZJ6R8BTA	DIODE	[M] △
D773	RVD18S133TA	DIODE	[M]
D901	18S291TA	DIODE	[M]
D903	MTZJ4R7BTA	DIODE	[M]
D908	MA167ATA	DIODE	[M]
D909	MA167ATA	DIODE	[M]
D921	RVD18S133TA	DIODE	[M]
D923	RVD18S133TA	DIODE	[M]
D924	MTZJ3R9ATA	DIODE	[M]
D925	RVD18S133TA	DIODE	[M]
D929	LN846RPH	DIODE	[M]
		VARIABLE RESISTORS	

Ref. No.	Part No.	Part Name & Description	Remarks
VR501	EUWMGB026B15	VR MOTOR VOLUME	[M]
VR502	EVJ02QF03G15	VR BALANCE CONTROL	[M]
VR511	EVJYA1F03C15	VR TONE CONTROL	[M]
VR512	EVJYA1F03C15	VR TONE CONTROL	[M]
		SWITCHES	
S946	EVQ21405R	SW POWER	[M]
S947	EVQ21405R	SW PHONO	[M]
S948	EVQ21405R	SW MUTING	[M]
S950	EVQ21405R	SW FM MODE	[M]
S951	EVQ21405R	SW BAND	[M]
S952	EVQ21405R	SW TUNING DOWN	[M]
S953	EVQ21405R	SW TUNING UP	[M]
S955	EVQ21405R	SW MEMORY	[M]
S956	EVQ21405R	SW CH DOWN	[M]
S957	EVQ21405R	SW CH UP	[M]
S960	EVQ21405R	SW TUNER	[M]
S961	EVQ21405R	SW CD	[M]
S962	EVQ21405R	SW TAPE	[M]
S964	EVQ21405R	SW VCR	[M]
S970	EVQ21405R	SW SEARCH	[M]
S971	EVQ21405R	SW EON	[M]
S972	EVQ21405R	SW PTY SELECT UP	[M]
S973	EVQ21405R	SW PTY SELECT DOWN	[M]
S974	EVQ21405R	SW DISPLAY MODE	[M]
S980	EVQ21405R	SW SPEAKER	[M]
		CONNECTORS	
CN101	RJU057W007	7P CONNECTOR	[M]
CN102	RJU057W007	7P CONNECTOR	[M]
CN501	RJU100W07	7P CONNECTOR	[M]
CN502	RJU100W04	4P CONNECTOR	[M]
CN651	RJSLA6603T1	3P TAPING CONNECTOR	[M]
CN701A	RJSLA6606T1	6P TAPING CONNECTOR	[M]
CN701B	RJSLA6606T1	6P TAPING CONNECTOR	[M]
CN751	SJS305-1	3P CONNECTOR	[M]
CN771	RJP2G4YA	CONNECTOR	[M]
CN901	RJU003K008M1	BOAD IN CONNECTOR	[M]
CN902	RJU003K008M1	BOAD IN CONNECTOR	[M]
CN903	RJU003K008M1	BOAD IN CONNECTOR	[M]
CN904	RJU003K008M1	BOAD IN CONNECTOR	[M]
CP101	RJT057W007-1	7P CONNECTOR	[M]
CP102	RJT057W007-1	7P CONNECTOR	[M]
CP501	RJT100W07	7P CONNECTOR	[M]
CP502	RJT100W04	4P CONNECTOR	[M]
CP901	RJT003K008-1	8P CONNECTOR	[M]
CP902	RJT003K008-1	8P CONNECTOR	[M]
CP903	RJT003K008-1	8P CONNECTOR	[M]
CP904	RJT003K008-1	8P CONNECTOR	[M]
		COILS & TRANSFORMERS	
L101	ELESN1R0MA	CHOKE COIL	[M]
L103	ELEXTR47MA9	CHOKE COIL	[M]
L105	RLQZB822KT-D	TAPING COIL	[M]
L106	RLQZB822KT-D	TAPING COIL	[M]
L151	SLM1B10-1M	A.B. FILTER	[M]
L191	ELESNR56MA	CHOKE COIL	[M]
L501	RLQZP1R0KT-Y	AXIAL COIL	[M]
L502	RLQZP1R0KT-Y	AXIAL COIL	[M]
L601	RLQYR73MW-E	CHOKE COIL	[M]
L602	RLQYR73MW-E	CHOKE COIL	[M]
L701	SLQZ650MH49	AC LINE COIL	[M] △
L751	ELESN101KA	CHOKE COIL	[M]
L901	RLQB101KTA-Y	CHOKE COIL	[M]
L902	RLQZP101KT-Y	AXIAL COIL	[M]
L903	RLQZP101KT-Y	AXIAL COIL	[M]
T701	RTP1N5B022	POWER TRANSFORMER	[M] △
T751	RTP115E003-V	SUB POWER TRANSFORMER	[M] △
		COMPONENT COMBINATION	

Ref. No.	Part No.	Part Name & Description	Remarks
Z101	RLA2Z002M-T	AM ANT. COIL	[M]
Z102	RLI2Z006M-T	AM IFT	[M]
Z120	ENV17290G1Y	FM TUNER PACK	[M]
Z751	ERZV10V511CS	ZENER	[M] △
Z891	RCDSPS4242N	REMOTE SENSOR	[M]
		CERAMIC FILTERS	
CF201	RLFFETMGD01L	CERAMIC CAPACITOR	[M]
CF202	RLFFETMGD01L	CERAMIC FILTER	[M]
CF901	RVCST4R00MT	CERAMIC OSCILLATOR	[M]
		RELAY	
RL601	RSY0013M-0	RELAY	[M]
RL751	RSY0019M-0	12V TV-5 RELAY	[M] △
		OSCILLATORS	
X101	RSXZ456KM07M	CERAMIC OSCILLATOR	[M]
X102	RLFDGTD01I	FM REZONATOR	[M]
X103	RSXD7M20C01	CRYSTAL 7.2 MHZ	[M]
X901	RSXC4M33S02T	CRYSTAL 4.33 MHZ	[M]
		DISPLAY TUBE	
FL901	RSL0233-F	FL	[M]
		FUSES	
F1	XBA2C16TB0	FUSE	[M] △
		FUSE HOLDERS	
FC701	EYF52BC	FUSE HOLDER	[M]
FC702	EYF52BC	FUSE HOLDER	[M]
		JACKS	
HP601	RJJ63TS01	HEADPHONES JACK	[M]
JK101	RJH4202-1	JK ANT TERMINAL	[M]
JK401	SJF3069N	JK LINE IN	[M]
JK402	SJF3069N	JK LINE IN	[M]
JK403	SJF3069N	JK LINE IN	[M]
JK601	RJR0054	JK SPEAKER TERMINAL	[M]
JK791	SJS9236-1	JK AC INLET	[M] △
		EARTH TERMINAL	
E401	SNE1004-2	EARTH TERMINAL	[M]
E601	SNE1004-2	EARTH TERMINAL	[M]
		WIRES	
W651	RWJ1803190CQ	WIRE	[M]
W701	RWJ1812300CQ	WIRE	[M]
W702	RWJ1807180CC	WIRE	[M]
		RESISTORS	
R103	ERDS2TJ101T	100 1/4W	[M]
R104	ERDS2TJ102T	1K 1/4W	[M]
R105	ERDS2TJ471T	470 1/4W	[M]
R106	ERDS2TJ224T	220K 1/4W	[M]
R107	ERDS2TJ471T	470 1/4W	[M]
R110	ERDS2TJ102T	1K 1/4W	[M]
R112	ERDS2TJ104T	100K 1/4W	[M]
R113	ERDS2TJ103T	10K 1/4W	[M]
R114	ERDS2TJ562T	5.6K 1/4W	[M]
R115	ERDS2TJ561T	560 1/4W	[M]
R116	ERDS2TJ102T	1K 1/4W	[M]
R117	ERDS2TJ473T	47K 1/4W	[M]
R118	ERDS2TJ562T	5.6K 1/4W	[M]
R119	ERDS2TJ183T	18K 1/4W	[M]

Ref. No.	Part No.	Part Name & Description	Remarks
R120	ERDS2TJ473T	47K 1/4W	[M]
R121	ERDS2TJ332T	3.3K 1/4W	[M]
R122	ERDS2TJ272T	2.7K 1/4W	[M]
R124	ERDS2TJ301T	300 1/4W	[M]
R125	ERDS2TJ472T	4.7K 1/4W	[M]
R126	ERDS2TJ472T	4.7K 1/4W	[M]
R127	ERDS2TJ103T	10K 1/4W	[M]
R128	ERDS2TJ820T	82 1/4W	[M]
R129	ERDS2TJ473T	47K 1/4W	[M]
R130	ERDS2TJ102T	1K 1/4W	[M]
R131	ERDS2TJ102T	1K 1/4W	[M]
R132	ERDS2TJ103T	10K 1/4W	[M]
R133	ERDS2TJ102T	1K 1/4W	[M]
R134	ERDS2TJ102T	1K 1/4W	[M]
R135	ERDS2TJ102T	1K 1/4W	[M]
R136	ERDS2TJ102T	1K 1/4W	[M]
R137	ERDS2TJ102T	1K 1/4W	[M]
R139	ERDS2TJ272T	2.7K 1/4W	[M]
R140	ERDS2TJ272T	2.7K 1/4W	[M]
R141	ERDS2TJ102T	1K 1/4W	[M]
R142	ERDS2TJ102T	1K 1/4W	[M]
R143	ERDS2TJ222T	2.2K 1/4W	[M]
R144	ERDS2TJ222T	2.2K 1/4W	[M]
R145	ERDS2TJ821T	820 1/4W	[M]
R146	ERDS2TJ821T	820 1/4W	[M]
R147	ERDS2TJ474T	470K 1/4W	[M]
R148	ERDS2TJ474T	470K 1/4W	[M]
R149	ERDS2TJ680T	68 1/4W	[M]
R171	ERDS2TJ102T	1K 1/4W	[M]
R172	ERDS2TJ102T	1K 1/4W	[M]
R173	ERDS2TJ471T	470 1/4W	[M]
R175	ERDS2TJ102T	1K 1/4W	[M]
R176	ERDS2TJ391T	390 1/4W	[M]
R181	ERDS2TJ332T	3.3K 1/4W	[M]
R401	ERDS2TJ102T	1K 1/4W	[M]
R402	ERDS2TJ102T	1K 1/4W	[M]
R405	ERDS2TJ102T	1K 1/4W	[M]
R406	ERDS2TJ102T	1K 1/4W	[M]
R407	ERDS2TJ102T	1K 1/4W	[M]
R408	ERDS2TJ102T	1K 1/4W	[M]
R411	ERDS2TJ102T	1K 1/4W	[M]
R412	ERDS2TJ102T	1K 1/4W	[M]
R413	ERDS2TJ102T	1K 1/4W	[M]
R414	ERDS2TJ102T	1K 1/4W	[M]
R415	ERDS2TJ102T	1K 1/4W	[M]
R416	ERDS2TJ102T	1K 1/4W	[M]
R417	ERDS2TJ473T	47K 1/4W	[M]
R418	ERDS2TJ473T	47K 1/4W	[M]
R419	ERDS2TJ104T	100K 1/4W	[M]
R420	ERDS2TJ104T	100K 1/4W	[M]
R421	ERDS2TJ104T	100K 1/4W	[M]
R422	ERDS2TJ104T	100K 1/4W	[M]
R423	ERDS2TJ102T	1K 1/4W	[M]
R424	ERDS2TJ102T	1K 1/4W	[M]
R425	ERDS2TJ103T	10K 1/4W	[M]
R426	ERDS2TJ103T	10K 1/4W	[M]
R427	ERDS2TJ103T	10K 1/4W	[M]
R440	ERDS1FVJ820T	82 1/2W	[M] △
R441	ERDS2TJ473T	47K 1/4W	[M]
R442	ERDS2TJ473T	47K 1/4W	[M]
R443	ERDS2TJ330T	33 1/4W	[M]
R451	ERDS2TJ224T	220K 1/4W	[M]
R452	ERDS2TJ224T	220K 1/4W	[M]
R453	ERDS2TJ391T	390 1/4W	[M]
R454	ERDS2TJ391T	390 1/4W	[M]
R455	ERDS2TJ563T	56K 1/4W	[M]
R456	ERDS2TJ563T	56K 1/4W	[M]
R457	ERDS2TJ271T	270 1/4W	[M]
R458	ERDS2TJ271T	270 1/4W	[M]
R459	ERDS2TJ680T	68 1/4W	[M]
R460	ERDS2TJ680T	68 1/4W	[M]
R461	ERDS2TJ184T	180K 1/4W	[M]
R462	ERDS2TJ184T	180K 1/4W	[M]
R463	ERDS2TJ123T	12K 1/4W	[M]

Ref. No.	Part No.	Part Name & Description	Remarks
R464	ERDS2TJ123T	12K 1/4W	[M]
R465	ERDS2TJ563T	56K 1/4W	[M]
R466	ERDS2TJ563T	56K 1/4W	[M]
R467	ERDS2TJ102T	1K 1/4W	[M]
R468	ERDS2TJ102T	1K 1/4W	[M]
R469	ERDS2TJ102T	1K 1/4W	[M]
R470	ERDS2TJ102T	1K 1/4W	[M]
R501	ERDS2TJ222T	2.2K 1/4W	[M]
R502	ERDS2TJ222T	2.2K 1/4W	[M]
R503	ERDS2TJ103T	10K 1/4W	[M]
R504	ERDS2TJ103T	10K 1/4W	[M]
R508	ERDS1FVJ2R2T	2.2 1/2W	[M] △
R511	ERDS2TJ471T	470 1/4W	[M]
R512	ERDS2TJ471T	470 1/4W	[M]
R513	ERDS2TJ474T	470K 1/4W	[M]
R514	ERDS2TJ474T	470K 1/4W	[M]
R515	ERDS2TJ474T	470K 1/4W	[M]
R516	ERDS2TJ474T	470K 1/4W	[M]
R517	ERDS2TJ821T	820 1/4W	[M]
R518	ERDS2TJ821T	820 1/4W	[M]
R519	ERDS2TJ392T	3.9K 1/4W	[M]
R520	ERDS2TJ392T	3.9K 1/4W	[M]
R521	ERDS2TJ223T	22K 1/4W	[M]
R522	ERDS2TJ223T	22K 1/4W	[M]
R523	ERDS2TJ392T	3.9K 1/4W	[M]
R524	ERDS2TJ392T	3.9K 1/4W	[M]
R525	ERDS2TJ222T	2.2K 1/4W	[M]
R526	ERDS2TJ222T	2.2K 1/4W	[M]
R527	ERDS2TJ122T	1.2K 1/4W	[M]
R528	ERDS2TJ122T	1.2K 1/4W	[M]
R529	ERDS2TJ273T	27K 1/4W	[M]
R530	ERDS2TJ273T	27K 1/4W	[M]
R531	ERDS2TJ332T	3.3K 1/4W	[M]
R532	ERDS2TJ332T	3.3K 1/4W	[M]
R533	ERDS2TJ332T	3.3K 1/4W	[M]
R534	ERDS2TJ332T	3.3K 1/4W	[M]
R543	ERDS2TJ102T	1K 1/4W	[M]
R544	ERDS2TJ102T	1K 1/4W	[M]
R545	ERDS2TJ824T	820K 1/4W	[M]
R546	ERDS2TJ332T	3.3K 1/4W	[M]
R601	ERDS2TJ221T	220 1/4W	[M]
R602	ERDS2TJ221T	220 1/4W	[M]
R603	ERDS2TJ563T	56K 1/4W	[M]
R604	ERDS2TJ563T	56K 1/4W	[M]
R605	ERDS2TJ182T	1.8K 1/4W	[M]
R606	ERDS2TJ182T	1.8K 1/4W	[M]
R607	ERDS2TJ563T	56K 1/4W	[M]
R608	ERDS2TJ563T	56K 1/4W	[M]
R609	ERDS2TJ100T	10 1/4W	[M]
R610	ERDS2TJ100T	10 1/4W	[M]
R611	ERDS1FVJ100T	10 1/2W	[M] △
R612	ERDS1FVJ100T	10 1/2W	[M] △
R613	ERDS2TJ102T	1K 1/4W	[M]
R614	ERDS2TJ102T	1K 1/4W	[M]
R615	ERDS2TJ184T	180K 1/4W	[M]
R616	ERDS2TJ154T	150K 1/4W	[M]
R619	ERDS2TJ684T	680K 1/4W	[M]
R620	ERDS2TJ473T	47K 1/4W	[M]
R621	ERD25FVJ180T	18 1/4W	[M]
R622	ERD25FVJ180T	18 1/4W	[M]
R623	ERDS2TJ684T	680K 1/4W	[M]
R624	ERDS2TJ154T	150K 1/4W	[M]
R625	ERD2FCVG470T	47 1/4W	[M]
R626	ERDS2TJ473T	47K 1/4W	[M]
R627	ERG1S101E	100 1W	[M] △
R628	ERG1S101E	100 1W	[M] △
R629	ERG1S101E	100 1W	[M] △
R630	ERG1S101E	100 1W	[M] △
R631	ERDS2TJ223T	22K 1/4W	[M]
R633	ERDS2TJ103T	10K 1/4W	[M]
R635	ERDS2TJ102T	1K 1/4W	[M]
R637	ERDS2TJ472T	4.7K 1/4W	[M]
R639	ERDS2TJ474T	470K 1/4W	[M]
R640	ERDS2TJ474T	470K 1/4W	[M]

Ref. No.	Part No.	Part Name & Description	Remarks
R641	ERDS2TJ221T	220 1/4W	[M]
R642	ERDS2TJ221T	220 1/4W	[M]
R643	ERDS2TJ124T	120K 1/4W	[M]
R644	ERDS2TJ124T	120K 1/4W	[M]
R645	ERDS2TJ473T	47K 1/4W	[M]
R646	ERDS2TJ274T	270K 1/4W	[M]
R671	ERDS2TJ223T	22K 1/4W	[M]
R672	ERDS2TJ223T	22K 1/4W	[M]
R675	ERDS2TJ682T	6.8K 1/4W	[M]
R681	ERDS2TJ270T	27 1/4W	[M]
R682	ERDS2TJ270T	27 1/4W	[M]
R683	ERDS2TJ270T	27 1/4W	[M]
R684	ERDS2TJ270T	27 1/4W	[M]
R685	ERDS2TJ270T	27 1/4W	[M]
R686	ERDS2TJ270T	27 1/4W	[M]
R687	ERDS2TJ270T	27 1/4W	[M]
R688	ERDS2TJ270T	27 1/4W	[M]
R689	ERDS2TJ270T	27 1/4W	[M]
R690	ERDS2TJ223T	22K 1/4W	[M]
R690	ERDS2TJ270T	27 1/4W	[M]
R691	ERDS2TJ270T	27 1/4W	[M]
R692	ERDS2TJ270T	27 1/4W	[M]
R693	ERDS2TJ270T	27 1/4W	[M]
R694	ERDS2TJ270T	27 1/4W	[M]
R695	ERDS2TJ102T	1K 1/4W	[M]
R696	ERDS2TJ102T	1K 1/4W	[M]
R699	ERDS2TJ332T	3.3K 1/4W	[M]
R705	ERD2FCVJ4R7T	4.7 1/4W	[M]
R707	ERDS2TJ332T	3.3K 1/4W	[M]
R708	ERDS2TJ102T	1K 1/4W	[M]
R711	ERD25FVJ221T	220 1/4W	[M]
R714	ERDS2TJ472T	4.7K 1/4W	[M]
R715	ERDS2TJ1R5T	1.5 1/4W	[M]
R716	ERDS2TJ1R5T	1.5 1/4W	[M]
R717	ERDS2TJ752T	7.5K 1/4W	[M]
R718	ERDS2TJ682T	6.8K 1/4W	[M]
R719	ERD2FCVJ6R8T	6.8 1/4W	[M]
R721	ERDS2TJ182T	1.8K 1/4W	[M]
R723	ERD2FCVJ4R7T	4.7 1/4W	[M]
R724	ERDS2TJ122T	1.2K 1/4W	[M]
R727	ERD25FVJ180T	18 1/4W	[M]
R728	ERD2FCVJ4R7T	4.7 1/4W	[M]
R729	ERDS2TJ152T	1.5K 1/4W	[M]
R754	ERDS2TJ102T	1K 1/4W	[M]
R772	ERDS2TJ104T	100K 1/4W	[M]
R773	ERDS2TJ103T	10K 1/4W	[M]
R774	ERDS2TJ223T	22K 1/4W	[M]
R775	ERDS2TJ332T	3.3K 1/4W	[M]
R777	ERDS2TJ220T	22 1/4W	[M]
R778	ERDS2TJ222T	2.2K 1/4W	[M]
R779	ERDS2TJ103T	10K 1/4W	[M]
R780	ERDS2TJ473T	47K 1/4W	[M]
R781	ERDS2TJ473T	47K 1/4W	[M]
R782	ERDS2TJ153T	15K 1/4W	[M]
R783	ERDS2TJ103T	10K 1/4W	[M]
R784	ERDS2TJ335T	3.3M 1/4W	[M]
R901	ERDS2TJ102T	1K 1/4W	[M]
R903	ERDS2TJ104T	100K 1/4W	[M]
R906	ERDS2TJ182T	1.8K 1/4W	[M]
R907	ERDS2TJ104T	100K 1/4W	[M]
R908	ERDS2TJ104T	100K 1/4W	[M]
R909	ERDS2TJ104T	100K 1/4W	[M]
R910	ERDS2TJ102T	1K 1/4W	[M]
R911	ERDS2TJ104T	100K 1/4W	[M]
R917	ERDS2TJ103T	10K 1/4W	[M]
R918	ERDS2TJ102T	1K 1/4W	[M]
R919	ERDS2TJ102T	1K 1/4W	[M]
R920	ERDS2TJ271T	270 1/4W	[M]
R921	ERDS2TJ121T	120 1/4W	[M]
R922	ERDS2TJ472T	4.7K 1/4W	[M]
R924	ERDS2TJ103T	10K 1/4W	[M]
R925	ERDS2TJ103T	10K 1/4W	[M]
R927	ERDS2TJ181T	180 1/4W	[M]
R929	ERDS2TJ101T	100 1/4W	[M]

Ref. No.	Part No.	Part Name & Description	Remarks
R930	ERDS2TJ101T	100 1/4W	[M]
R941	ERDS2TJ472T	4.7K 1/4W	[M]
R943	ERDS2TJ102T	1K 1/4W	[M]
R944	ERDS2TJ104T	100K 1/4W	[M]
R945	ERDS2TJ104T	100K 1/4W	[M]
R946	ERDS2TJ103T	10K 1/4W	[M]
R947	ERDS2TJ103T	10K 1/4W	[M]
R948	ERDS2TJ103T	10K 1/4W	[M]
R949	ERDS2TJ103T	10K 1/4W	[M]
R950	ERDS2TJ102T	1K 1/4W	[M]
R951	ERDS2TJ122T	1.2K 1/4W	[M]
R952	ERDS2TJ152T	1.5K 1/4W	[M]
R953	ERDS2TJ182T	1.8K 1/4W	[M]
R954	ERDS2TJ222T	2.2K 1/4W	[M]
R955	ERDS2TJ332T	3.3K 1/4W	[M]
R956	ERDS2TJ472T	4.7K 1/4W	[M]
R957	ERDS2TJ682T	6.8K 1/4W	[M]
R960	ERDS2TJ102T	1K 1/4W	[M]
R961	ERDS2TJ122T	1.2K 1/4W	[M]
R962	ERDS2TJ152T	1.5K 1/4W	[M]
R963	ERDS2TJ182T	1.8K 1/4W	[M]
R964	ERDS2TJ222T	2.2K 1/4W	[M]
R970	ERDS2TJ102T	1K 1/4W	[M]
R971	ERDS2TJ122T	1.2K 1/4W	[M]
R972	ERDS2TJ152T	1.5K 1/4W	[M]
R973	ERDS2TJ182T	1.8K 1/4W	[M]
R974	ERDS2TJ222T	2.2K 1/4W	[M]
		CAPACITORS	
C101	ECBT1C103NS5	0.01 16V	[M]
C103	ECBT1C103NS5	0.01 16V	[M]
C104	ECBT1H102KB5	1000P 50V	[M]
C105	ECBT1H470J5	47P 50V	[M]
C106	ECBT1C103NS5	0.01 16V	[M]
C107	ECBT1H473ZF5	0.047 50V	[M]
C108	ECBT1H8R2KC5	8.2P 50V	[M]
C109	ECBT1C103NS5	0.01 16V	[M]
C110	ECBT1C103NS5	0.01 16V	[M]
C111	ECEA1EKA4R7B	4.7 25V	[M]
C112	ECBT1C103NS5	0.01 16V	[M]
C113	ECBT1H102KB5	1000P 50V	[M]
C114	ECEA1HKA3R3B	3.3 50V	[M]
C115	ECEA1EKA4R7B	4.7 25V	[M]
C116	ECBT1C822MS5	8200P 16V	[M]
C117	ECQB1H471JM3	470P 50V	[M]
C118	ECQB1H103JM3	0.01 50V	[M]
C119	ECQB1H103JM3	0.01 50V	[M]
C120	ECEA1HKA010B	1 50V	[M]
C121	ECEA1HKA010B	1 50V	[M]
C122	ECEA1HKA2R2B	2.2 50V	[M]
C123	ECEA1HKA010B	1 50V	[M]
C124	ECBT1H102KB5	1000P 50V	[M]
C125	ECBT1H150JC5	15P 50V	[M]
C126	ECBT1H104ZF5	0.1 50V	[M]
C127	ECEA1CKA220B	22 16V	[M]
C128	ECBT1C103NS5	0.01 16V	[M]
C129	ECEA0JKA101B	100 6.3V	[M]
C130	ECEA0JKA101B	100 6.3V	[M]
C131	ECBT1C103NS5	0.01 16V	[M]
C132	ECBT1H102KB5	1000P 50V	[M]
C133	ECBT1H150JC5	15P 50V	[M]
C134	ECBT1H180JC5	18P 50V	[M]
C135	ECBT1C103MS5	0.01 16V	[M]
C136	ECBT1C103MS5	0.01 16V	[M]
C137	ECBT1H561KB5	560P 50V	[M]
C138	ECBT1H561KB5	560P 50V	[M]
C139	ECQB1H682JM3	6800P 50V	[M]
C140	ECQB1H682JM3	6800P 50V	[M]
C141	ECEA1HKA010B	1 50V	[M]
C142	ECEA1HKA010B	1 50V	[M]
C143	ECEA1HKA010B	1 50V	[M]
C144	ECEA1HKA010B	1 50V	[M]
C145	ECBT1H220JC5	22P 50V	[M]

Ref. No.	Part No.	Part Name & Description	Remarks
C146	ECBT1H331KB5	330P 50V	[M]
C147	ECBT1H102KB5	1000P 50V	[M]
C148	ECBT1C103NS5	0.01 16V	[M]
C149	ECBT1C103NS5	0.01 16V	[M]
C150	ECBT1H104ZF5	0.1 50V	[M]
C172	ECBT1H331KB5	330P 50V	[M]
C173	ECEA1CKA220B	22 16V	[M]
C174	ECEA1CKA101B	100 16V	[M]
C175	ECBT1C103NS5	0.01 16V	[M]
C176	ECBT1C103NS5	0.01 16V	[M]
C181	ECBT1H471KB5	470P 50V	[M]
C196	ECBT1H102KB5	1000P 50V	[M]
C401	ECEA1VKA4R7B	4.7 35V	[M]
C402	ECBT1E103ZF5	0.01 25V	[M]
C403	ECBT1E103ZF5	0.01 25V	[M]
C404	ECEA1VKA4R7B	4.7 35V	[M]
C405	ECBT1H101KB5	100P 50V	[M]
C406	ECBT1H102KB5	1000P 50V	[M]
C409	ECA1CM220B	22 16V	[M]
C410	ECA1CM220B	22 16V	[M]
C411	ECBT1H101KB5	100P 50V	[M]
C412	ECBT1H101KB5	100P 50V	[M]
C413	ECA1CM100B	10 16V	[M]
C414	ECA1CM100B	10 16V	[M]
C415	ECBT1E103ZF5	0.01 25V	[M]
C416	ECBT1E103ZF5	0.01 25V	[M]
C417	ECBT1H101KB5	100P 50V	[M]
C418	ECBT1H101KB5	100P 50V	[M]
C419	ECBT1H331KB5	330P 50V	[M]
C420	ECBT1H331KB5	330P 50V	[M]
C421	ECBT1H331KB5	330P 50V	[M]
C422	ECBT1H331KB5	330P 50V	[M]
C425	ECBT1H101KB5	100P 50V	[M]
C426	ECBT1H101KB5	100P 50V	[M]
C427	ECBT1H221KB5	220P 50V	[M]
C428	ECBT1H221KB5	220P 50V	[M]
C431	ECA1CM100B	10 16V	[M]
C432	ECA1CM100B	10 16V	[M]
C440	ECBT1E103ZF5	0.01 25V	[M]
C451	ECEA1VKA4R7B	4.7 35V	[M]
C452	ECEA1VKA4R7B	4.7 35V	[M]
C453	ECBT1H100JC5	10P 50V	[M]
C454	ECBT1H100JC5	10P 50V	[M]
C455	ECBT1H102KB5	1000P 50V	[M]
C456	ECBT1H102KB5	1000P 50V	[M]
C457	ECEA1AU330B	33 10V	[M]
C458	ECEA1AU330B	33 10V	[M]
C459	ECFR1E223KR	0.022 25V	[M]
C460	ECFR1E223KR	0.022 25V	[M]
C461	ECFR1E682KR	6800P 25V	[M]
C462	ECFR1E682KR	6800P 25V	[M]
C463	ECEA1VKA4R7B	4.7 35V	[M]
C464	ECEA1VKA4R7B	4.7 35V	[M]
C465	ECBT1E103ZF5	0.01 25V	[M]
C466	ECBT1E103ZF5	0.01 25V	[M]
C469	ECBT1H181KB5	180P 50V	[M]
C470	ECBT1H181KB5	180P 50V	[M]
C503	ECEA0JKA101B	100 6.3V	[M]
C504	ECEA0JKA101B	100 6.3V	[M]
C505	ECFR1C104MR	0.1 16V	[M]
C506	ECFR1C104MR	0.1 16V	[M]
C511	ECEA1HKA3R3B	3.3 50V	[M]
C512	ECEA1HKA3R3B	3.3 50V	[M]
C513	ECBT1H150J5	15P 50V	[M]
C514	ECBT1H150J5	15P 50V	[M]
C515	ECBT1H221KB5	220P 50V	[M]
C516	ECBT1H221KB5	220P 50V	[M]
C517	ECBT1H330J5	33P 50V	[M]
C518	ECBT1H330J5	33P 50V	[M]
C519	ECEA1VKA4R7B	4.7 35V	[M]
C520	ECEA1VKA4R7B	4.7 35V	[M]
C521	ECEA1VKA4R7B	4.7 35V	[M]
C522	ECEA1VKA4R7B	4.7 35V	[M]
C523	ECFR1E123KR	0.012 25V	[M]

Ref. No.	Part No.	Part Name & Description	Remarks
C524	ECFR1E123KR	0.012 25V	[M]
C525	ECQV1H683JZ3	0.068 50V	[M]
C526	ECQV1H683JZ3	0.068 50V	[M]
C527	ECBT1C562KR5	5600P 16V	[M]
C528	ECBT1C562KR5	5600P 16V	[M]
C529	ECQB1H273JF3	0.027 50V	[M]
C530	ECQB1H273JF3	0.027 50V	[M]
C531	ECBT1H103KB5	0.01 50V	[M]
C532	ECBT1H103KB5	0.01 50V	[M]
C533	ECEA1CKA100B	10 16V	[M]
C534	ECEA1CKA100B	10 16V	[M]
C536	ECBT1H103KB5	0.01 50V	[M]
C601	ECEA1HN2R2SB	2.2 50V	[M]
C602	ECEA1HN2R2SB	2.2 50V	[M]
C603	ECBT1H561KB5	560P 50V	[M] EB
C603	ECBT1H681KB5	680P 50V	[M] EG E
C604	ECBT1H561KB5	560P 50V	[M] EB
C604	ECBT1H681KB5	680P 50V	[M] EG E
C605	ECA1JM330B	33 6.3V	[M]
C606	ECA1JM330B	33 6.3V	[M]
C607	ECCR1H100K5	10P 50V	[M]
C608	ECCR1H100K5	10P 50V	[M]
C609	ECBT1H151KB5	150P 50V	[M] EB
C609	ECBT1H221KB5	220P 50V	[M] EG E
C610	ECBT1H151KB5	150P 50V	[M] EB
C610	ECBT1H221KB5	220P 50V	[M] EG E
C611	ECQV1H473JZ3	0.047 50V	[M]
C612	ECQV1H473JZ3	0.047 50V	[M]
C613	ECBT1H681KB5	680P 50V	[M]
C614	ECBT1H681KB5	680P 50V	[M]
C615	ECEA2AN2R2SB	2.2 100V	[M]
C616	ECEA2AU100B	10 100V	[M]
C617	ECA1HM470B	47 50V	[M]
C618	ECEA2AU100B	10 100V	[M]
C621	ECEA2AU100B	10 100V	[M]
C623	ECCR1H223ZF5	0.022 50V	[M]
C624	ECCR1H223ZF5	0.022 50V	[M]
C625	ECEA1HN100SB	10 50V	[M]
C626	ECEA1HN100SB	10 50V	[M]
C627	ECCR2H101KB5	100P 500V	[M]
C628	ECBT1H101KB5	100P 50V	[M]
C629	ECBT1E223ZF5	0.022 25V	[M]
C631	ECCR1H102KB5	1000P 50V	[M] EG E
C632	ECCR1H102KB5	1000P 50V	[M] EG E
C683	ECBT1C332KR5	3300P 16V	[M]
C684	ECBT1C332KR5	3300P 16V	[M]
C685	ECBT1H103KB5	0.01 50V	[M]
C701	ECBT1E103ZF5	0.01 25V	[M]
C702	ECQE2104KF3	0.1 250V	[M]
C703	EC0S1JP472BB	4700P 63V	[M]
C704	EC0S1JP472BB	4700P 63V	[M]
C705	ECA1HM332E	3300 50V	[M] △
C706	ECA1HM332E	3300 50V	[M] △
C707	ECA1VM101B	100 35V	[M]
C708	ECCR1H103ZF5	0.01 50V	[M]
C709	ECA1CM330B	33 16V	[M]
C710	ECBT1E103ZF5	0.01 25V	[M]
C711	ECCR1H103ZF5	0.01 50V	[M]
C712	ECA1HM470B	47 50V	[M]
C713	ECCR1H103ZF5	0.01 50V	[M]
C716	ECEA2AU100B	10 100V	[M]
C720	ECA1EM220B	22 25V	[M]
C722	ECQE2104KF3	0.1 250V	[M]
C751	ECKWRS102MBC	1000P 400V	[M] △
C752	ECCR1H103ZF5	0.01 50V	[M]
C753	ECA1EM102E	1000 25V	[M] △
C756	ECBT1E103ZF5	0.01 25V	[M]
C757	ECA1CM470B	47 16V	[M]
C758	ECA1AM101B	100 10V	[M]
C759	ECA1EM220B	22 25V	[M]
C771	ECA1HM2R2B	2.2 50V	[M]
C772	ECA1CM100B	10 16V	[M]
C772	ECA1CM101B	100 16V	[M]
C773	ECBT1E223ZF5	0.022 25V	[M]

Ref. No.	Part No.	Part Name & Description	Remarks
C774	ECA0JM221B	220 6.3V	[M]
C901	ECEA0JU102B	1000 6.3V	[M]
C902	ECBT1H104KB5	0.1 50V	[M]
C903	ECBT1H103KB5	0.01 50V	[M]
C904	ECEA0JU102B	1000 6.3V	[M]
C905	ECBT1H103KB5	0.01 50V	[M]
C906	ECEA0JKA101B	100 6.3V	[M]
C908	ECBT1H103KB5	0.01 50V	[M]
C909	ECEA1VKA220B	22 35V	[M]
C910	ECEA1VKA220B	22 35V	[M]
C911	ECEA1VKA220B	22 35V	[M]
C912	ECEA1VKA220B	22 35V	[M]
C913	ECEA1VKA100B	10 35V	[M]
C914	ECEA1VKA100B	10 35V	[M]
C916	ECEA1HKA010B	1 50V	[M]
C917	ECA0JM101B	100 6.3V	[M]
C918	ECEA0JKA101B	100 6.3V	[M]
C920	ECEA1HKA010B	1 50V	[M]
C934	ECBT1H101KB5	100P 50V	[M]
C937	ECBT1H101KB5	100P 50V	[M]
C943	ECBT1H331KB5	330P 50V	[M]
C944	ECEA1CKA100B	10 16V	[M]
C945	ECBT1H103KB5	0.01 50V	[M]
C946	ECBT1H470J5	47P 50V	[M]
C947	ECBT1H470J5	47P 50V	[M]
C948	ECBT1H103KB5	0.01 50V	[M]
C962	ECBT1H561KB5	560P 50V	[M]
C963	ECBT1H102KB5	1000P 50V	[M]

14.3. Packing Materials & Accessories Parts List

Ref. No.	Part No.	Part Name & Description	Remarks
		PACKING MATERIALS	
P1	RPG4756	PACKING CASE	[M] E
P1	RPG4757	PACKING CASE	[M] EB EG
P2	RPN1153	POLYFOAM	[M]
P3	RPFK0005	MIRAMAT BAG	[M]
		ACCESSORIES	
A1	EUR644866	REMOTE CONTROL	[M]

Ref. No.	Part No.	Part Name & Description	Remarks
A1-1	UR64EC1822H	R/C BATTERY COVER	[M]
A2	RJA0019-2K	AC CORD (SF)	[M] EG E
A2	VJA0733	AC CORD (SF)	[M] EB
A3	RQT5223-1E	O/I BOOK (Sw/Sp/En)	[M] E
A3	RQT5224-1R	O/I BOOK (Po/Cz/Ru)	[M] E
A3	RQT5225-1D	O/I BOOK (Fr/It/Ge)	[M] EG
A3	RQT5226-1H	O/I BOOK (Da/Du)	[M] EG
A3	RQT5227-1B	O/I BOOK (En)	[M] EB
A4	RSA0007	FM ANTENNA	[M]
A5	RSA0010	LOOP ANT UNIT	[M]
A6	SJP9009	ANT ADAPTER	[M] EB

14.4. Packaging

ACCESSORIES CASE

A1 : REMOTE CONTROL

A2 : AC CORD

A3 : O/I BOOK

A4 : FM ANTENNA

A5 : LOOP ANT UNIT

